



CATÁLOGO

BOMAGUHD1021

EDICIÓN

2021

BOMBAS DE AGUA GATES®

SERVICIO PESADO





DRIVEN BY POSSIBILITY™



BOMBAS DE AGUA GATES® SERVICIO PESADO

AGCO.....	2
CATERPILLAR.....	2
DODGE.....	3
FORD.....	4
FREIGHTLINER.....	4
INTERNATIONAL/NAVISTAR.....	9
JOHN DEERE.....	15
KENWORTH.....	15
MACK.....	18
MARCO POLO.....	18
NEW HOLLAND.....	18
PETERBILT.....	18
SCANIA.....	21
STERLING.....	21
TEREX.....	22
VOLVO.....	22
NO. DE PARTE.....	23
APLICACIÓN POR MOTOR.....	36
BÚSQUEDA POR IMAGEN.....	37

AGCO

MODELO	MOTOR	AÑOS	DESCRIPCIÓN	NO. PARTE
LT75	CUMMINS 4 CIL 4.5 L DIÉSEL	2004-2005	C/O-RING	42291
LT90	CUMMINS 4 CIL 4.5 L DIÉSEL	2004-2005	C/O-RING	42291

CATERPILLAR

*EN ESTAS APLICACIONES TOMAR COMO REFERENCIA EL TIPO DE MOTOR, YA QUE NO APLICA A UN RANGO DE AÑOS EN ESPECÍFICO.

MODELO	MOTOR	AÑOS	DESCRIPCIÓN	NO. PARTE
345B (2NW)	CATERPILLAR 3176TA DIÉSEL	*	C/8 O-RING; C/3 JUNTAS	44060HD
345B (2ZW)	CATERPILLAR 3176TA DIÉSEL	*	C/8 O-RING; C/3 JUNTAS	44060HD
345B (6MW)	CATERPILLAR 3176TA DIÉSEL	*	C/8 O-RING; C/3 JUNTAS	44060HD
345B (6XS)	CATERPILLAR 3176TA DIÉSEL	*	C/8 O-RING; C/3 JUNTAS	44060HD
345B (8KW)	CATERPILLAR 3176TA DIÉSEL	*	C/8 O-RING; C/3 JUNTAS	44060HD
345B (AMD)	CATERPILLAR 3176TA DIÉSEL	*	C/8 O-RING; C/3 JUNTAS	44060HD
345B (AMJ)	CATERPILLAR 3176TA DIÉSEL	*	C/8 O-RING; C/3 JUNTAS	44060HD
345B (AMN)	CATERPILLAR 3176TA DIÉSEL	*	C/8 O-RING; C/3 JUNTAS	44060HD
345B (AYR)	CATERPILLAR 3176TA DIÉSEL	*	C/8 O-RING; C/3 JUNTAS	44060HD
345B (BFG)	CATERPILLAR 3176TA DIÉSEL	*	C/8 O-RING; C/3 JUNTAS	44060HD
345B (CFM)	CATERPILLAR 3176C DIÉSEL	*	C/8 O-RING; C/3 JUNTAS	44060HD
345B II (AGS)	CATERPILLAR 3176C DIÉSEL	*	C/8 O-RING; C/3 JUNTAS	44060HD
345B II (AKJ)	CATERPILLAR 3176C DIÉSEL	*	C/8 O-RING; C/3 JUNTAS	44060HD
345B II (AKX)	CATERPILLAR 3176C DIÉSEL	*	C/8 O-RING; C/3 JUNTAS	44060HD
345B II (ALB)	CATERPILLAR 3176C DIÉSEL	*	C/8 O-RING; C/3 JUNTAS	44060HD
345B II (ALD)	CATERPILLAR 3176C DIÉSEL	*	C/8 O-RING; C/3 JUNTAS	44060HD
345B II (ALL)	CATERPILLAR 3176C DIÉSEL	*	C/8 O-RING; C/3 JUNTAS	44060HD
345B II (CCC)	CATERPILLAR 3176C DIÉSEL	*	C/8 O-RING; C/3 JUNTAS	44060HD
345B II (CDJ)	CATERPILLAR 3176C DIÉSEL	*	C/8 O-RING; C/3 JUNTAS	44060HD
345B II (DCW)	CATERPILLAR 3176C DIÉSEL	*	C/8 O-RING; C/3 JUNTAS	44060HD
345B II (DET)	CATERPILLAR 3176C DIÉSEL	*	C/8 O-RING; C/3 JUNTAS	44060HD
345B II (FEE)	CATERPILLAR 3176C DIÉSEL	*	C/8 O-RING; C/3 JUNTAS	44060HD
345B II MH (APB)	CATERPILLAR 3176C DIÉSEL	*	C/8 O-RING; C/3 JUNTAS	44060HD
345B L (2SW)	CATERPILLAR 3176C DIÉSEL	*	C/8 O-RING; C/3 JUNTAS	44060HD
345B L (3MW)	CATERPILLAR 3176C DIÉSEL	*	C/8 O-RING; C/3 JUNTAS	44060HD
345B L (4SS)	CATERPILLAR 3176C DIÉSEL	*	C/8 O-RING; C/3 JUNTAS	44060HD
345B L (5WS)	CATERPILLAR 3176C DIÉSEL	*	C/8 O-RING; C/3 JUNTAS	44060HD
345B L (7KS)	CATERPILLAR 3176C DIÉSEL	*	C/8 O-RING; C/3 JUNTAS	44060HD
345B L (8RW)	CATERPILLAR 3176C DIÉSEL	*	C/8 O-RING; C/3 JUNTAS	44060HD
345B L (9CW)	CATERPILLAR 3176C DIÉSEL	*	C/8 O-RING; C/3 JUNTAS	44060HD
345B L (9GS)	CATERPILLAR 3176C DIÉSEL	*	C/8 O-RING; C/3 JUNTAS	44060HD
345C	CATERPILLAR 6 CIL 763 DIÉSEL	*	C/O-RING	43564HD
345C L	CATERPILLAR 6 CIL 763 DIÉSEL	*	C/O-RING	43564HD
345D	CATERPILLAR 6 CIL 763 DIÉSEL	*	C/O-RING	43564HD
345D L	CATERPILLAR 6 CIL 763 DIÉSEL	*	C/O-RING	43564HD
349D	CATERPILLAR 6 CIL 763 DIÉSEL	*	C/O-RING	43564HD
349D L	CATERPILLAR 6 CIL 763 DIÉSEL	*	C/O-RING	43564HD
365B (9PZ)	CATERPILLAR 3196 DIÉSEL	*	C/8 O-RING; C/3 JUNTAS	44060HD
365B (9TZ)	CATERPILLAR 3196 DIÉSEL	*	C/8 O-RING; C/3 JUNTAS	44060HD
365B (BTH)	CATERPILLAR 3196 DIÉSEL	*	C/8 O-RING; C/3 JUNTAS	44060HD
365B (CFJ)	CATERPILLAR 3196 DIÉSEL	*	C/8 O-RING; C/3 JUNTAS	44060HD
365B (CTY)	CATERPILLAR 3196 DIÉSEL	*	C/8 O-RING; C/3 JUNTAS	44060HD

CATERPILLAR (CONTINUACIÓN)

*EN ESTAS APLICACIONES TOMAR COMO REFERENCIA EL TIPO DE MOTOR, YA QUE NO APLICA A UN RANGO DE AÑOS EN ESPECÍFICO.

MODELO	MOTOR	AÑOS	DESCRIPCIÓN	NO. PARTE
365B (PEG)	CATERPILLAR 3196 DIÉSEL	*	C/8 O-RING; C/3 JUNTAS	44060HD
365B (SDL)	CATERPILLAR 3196 DIÉSEL	*	C/8 O-RING; C/3 JUNTAS	44060HD
365B II (DER)	CATERPILLAR 3196 DIÉSEL	*	C/8 O-RING; C/3 JUNTAS	44060HD
365B II (JMB)	CATERPILLAR 3196 DIÉSEL	*	C/8 O-RING; C/3 JUNTAS	44060HD
365B L (4XZ)	CATERPILLAR 3196 DIÉSEL	*	C/8 O-RING; C/3 JUNTAS	44060HD
365B L (9TZ)	CATERPILLAR 3196 DIÉSEL	*	C/8 O-RING; C/3 JUNTAS	44060HD
365B L (AGD)	CATERPILLAR 3196 DIÉSEL	*	C/8 O-RING; C/3 JUNTAS	44060HD
365C (ELC)	CATERPILLAR C15 DIÉSEL	*	C/6 O-RING; C/JUNTA	44062HD
365C (FEN)	CATERPILLAR C15 DIÉSEL	*	C/6 O-RING; C/JUNTA	44062HD
365C (MCS)	CATERPILLAR C15 DIÉSEL	*	C/6 O-RING; C/JUNTA	44062HD
365C (MEM)	CATERPILLAR C15 DIÉSEL	*	C/6 O-RING; C/JUNTA	44062HD
365C (PAR)	CATERPILLAR C15 DIÉSEL	*	C/6 O-RING; C/JUNTA	44062HD
365C L (MCY)	CATERPILLAR C15 DIÉSEL	*	C/6 O-RING; C/JUNTA	44062HD
365C L MH (GWC)	CATERPILLAR C15 DIÉSEL	*	C/6 O-RING; C/JUNTA	44062HD
374D L (PAP)	CATERPILLAR C15 DIÉSEL	*	C/6 O-RING; C/JUNTA	44062HD
374D L (PAS)	CATERPILLAR C15 DIÉSEL	*	C/6 O-RING; C/JUNTA	44062HD
374D L (PAX)	CATERPILLAR C15 DIÉSEL	*	C/6 O-RING; C/JUNTA	44062HD
374D L (PIA)	CATERPILLAR C15 DIÉSEL	*	C/6 O-RING; C/JUNTA	44062HD
385C (JCM)	CATERPILLAR C18 DIÉSEL	*	C/6 O-RING; C/JUNTA	44062HD
385C (KBC)	CATERPILLAR C18 DIÉSEL	*	C/6 O-RING; C/JUNTA	44062HD
385C (KKK)	CATERPILLAR C18 DIÉSEL	*	C/6 O-RING; C/JUNTA	44062HD
385C (MNZ)	CATERPILLAR C18 DIÉSEL	*	C/6 O-RING; C/JUNTA	44062HD
385C FS (EAM)	CATERPILLAR C18 DIÉSEL	*	C/6 O-RING; C/JUNTA	44062HD
385C FS (T2F)	CATERPILLAR C18 DIÉSEL	*	C/6 O-RING; C/JUNTA	44062HD
385C L (EDA)	CATERPILLAR C18 DIÉSEL	*	C/6 O-RING; C/JUNTA	44062HD
385C L (KGB)	CATERPILLAR C18 DIÉSEL	*	C/6 O-RING; C/JUNTA	44062HD
385C L (SBE)	CATERPILLAR C18 DIÉSEL	*	C/6 O-RING; C/JUNTA	44062HD
385C L (T2E)	CATERPILLAR C18 DIÉSEL	*	C/6 O-RING; C/JUNTA	44062HD
385C L MH (WAW)	CATERPILLAR C18 DIÉSEL	*	C/6 O-RING; C/JUNTA	44062HD
390D (BYP)	CATERPILLAR C18 DIÉSEL	*	C/6 O-RING; C/JUNTA	44062HD
390D (KCZ)	CATERPILLAR C18 DIÉSEL	*	C/6 O-RING; C/JUNTA	44062HD
390D L (WAG)	CATERPILLAR C18 DIÉSEL	*	C/6 O-RING; C/JUNTA	44062HD
390D L (WAP)	CATERPILLAR C18 DIÉSEL	*	C/6 O-RING; C/JUNTA	44062HD
390D L (WBT)	CATERPILLAR C18 DIÉSEL	*	C/6 O-RING; C/JUNTA	44062HD
W345B II (ANJ)	CATERPILLAR 3176C DIÉSEL	2002-2007	C/8 O-RING; C/3 JUNTAS	44060HD
W345B II (CDY)	CATERPILLAR 3176C DIÉSEL	2002-2007	C/8 O-RING; C/3 JUNTAS	44060HD
W345C MH	CATERPILLAR 6 CIL. 763 DIÉSEL	*	C/O-RING	43564HD

DODGE

MODELO	MOTOR	AÑOS	DESCRIPCIÓN	NO. PARTE
RAM 4500 HD	CUMMINS 6 CIL. 6.7 L DIÉSEL	2008-2012	C/O-RING	42291
RAM 4500 HD	CUMMINS DIÉSEL 6.7 L	2013-2018	C/O-RING	42133
RAM 5000 HD	CUMMINS 6 CIL. 6.7 L DIÉSEL	2008-2012	C/O-RING	42291
RAM 5500	CUMMINS DIÉSEL 6.7 L	2013-2018	C/O-RING	42133

FORD

MODELO	MOTOR	AÑOS	DESCRIPCIÓN	NO. PARTE
F650 SUPER DUTY	CUMMINS ISB DIÉSEL	2007-2008	C/O-RING	42291
F750 SUPER DUTY	CUMMINS ISB DIÉSEL	2007-2007	C/O-RING	42291
L8000	CATERPILLAR 3406 DIÉSEL	1994-1997	C/5 O-RING; C/4 JUNTAS	44054HD
L8000	CUMMINS L10 DIÉSEL	1991-1992	POLEA LOCA DE BA 43307HD	41175HD
L8000	CUMMINS N14 DIÉSEL	1993-1998	C/O-RING; C/2 JUNTAS	44052HD
L8000	DETROIT DIÉSEL SERIES 60 DIÉSEL	1996-1998	C/2 O-RING	44066HD
L8000	DETROIT DIÉSEL SERIES 60 DIÉSEL	1996-1998	C/2 O-RING	46002HD
L9000	CATERPILLAR 3406 DIÉSEL	1994-1997	C/5 O-RING; C/4 JUNTAS	44054HD
L9000	CUMMINS 6 CIL. 14.0 L DIÉSEL	1985-1985	C/O-RING; C/2 JUNTAS	44092HD
L9000	CUMMINS 6 CIL. 14.0 L DIÉSEL	1986-1989	C/O-RING; C/2 JUNTAS	44092HD
L9000	CUMMINS 6 CIL. 14.0 L DIÉSEL	1990-1990	C/O-RING; C/2 JUNTAS	44052HD
L9000	CUMMINS L10 DIÉSEL	1991-1997	POLEA LOCA DE BA 43307HD	41175HD
L9000	CUMMINS N14 DIÉSEL	1991-1997	C/O-RING; C/2 JUNTAS	44052HD
L9000	DETROIT DIÉSEL 6 CIL. 11.1 L DIÉSEL	1994-1997	C/2 O-RING	44066HD
L9000	DETROIT DIÉSEL 6 CIL. 11.1 L DIÉSEL	1994-1997	C/2 O-RING	46002HD
L9000	DETROIT DIÉSEL 6 CIL. 12.7 L DIÉSEL	1996-1997	C/2 O-RING	44066HD
L9000	DETROIT DIÉSEL 6 CIL. 12.7 L DIÉSEL	1996-1997	C/2 O-RING	46002HD
L9000	DETROIT DIÉSEL SERIES 60 DIÉSEL	1991-1993	C/2 O-RING	44066HD
L9000	DETROIT DIÉSEL SERIES 60 DIÉSEL	1991-1993	C/2 O-RING	46002HD

FREIGHTLINER

MODELO	MOTOR	AÑOS	DESCRIPCIÓN	NO. PARTE
114SD	DETROIT DIÉSEL DD13 DIÉSEL	2012-2019	C/O-RING	44057HD
122SD	CUMMINS ISX15 DIÉSEL	2014-2017	C/2 O-RING	45052HD
122SD	DETROIT DIÉSEL DD13 DIÉSEL	2014-2019	C/O-RING	44057HD
122SD	DETROIT DIÉSEL DD15 DIÉSEL	2014-2019	C/O-RING	44057HD
122SD	DETROIT DIÉSEL DD16 DIÉSEL	2014-2019	C/O-RING	44057HD
ARGOSY	DETROIT DIÉSEL 6 CIL. 14.0 L	2007-2007	C/EGR; C/2 O-RING	46004HD
BUSINESS CLASS M2	CATERPILLAR 3126 DIÉSEL	2004-2004	C/2 O-RING	43554HD
BUSINESS CLASS M2	CATERPILLAR 3126 DIÉSEL	2007-2007	C/O-RING	43561HD
BUSINESS CLASS M2	CATERPILLAR C11 DIÉSEL	2004-2006	C/O-RING	43564HD
BUSINESS CLASS M2	CATERPILLAR C13 DIÉSEL	2004-2007	C/O-RING	43564HD
BUSINESS CLASS M2	CATERPILLAR C7 DIÉSEL	2007-2007	C/O-RING	43561HD
BUSINESS CLASS M2	DETROIT DIÉSEL DD13 DIÉSEL	2010-2016	C/O-RING	44057HD
BUSINESS CLASS M2	DETROIT DIÉSEL DD13 DIÉSEL	2017-2019	C/O-RING	44057HD
BUSINESS CLASS M2	MERCEDES-BENZ MBE 900 DIÉSEL	2006-2015	C/O-RING; C/JUNTA	45050HD
BUSINESS CLASS M2	MERCEDES-BENZ OM906 DIÉSEL	2006-2006	C/O-RING; C/JUNTA	45050HD
CASCADIA	CATERPILLAR C15 DIÉSEL	2008-2009	C/6 O-RING; C/JUNTA	44062HD
CASCADIA	CUMMINS ISX DIÉSEL	2009-2009	C/2 O-RING	45052HD
CASCADIA	CUMMINS ISX15 DIÉSEL	2010-2016	C/2 O-RING	45052HD
CASCADIA	CUMMINS ISX15 DIÉSEL	2015-2015	C/O-RING	44057HD
CASCADIA	DETROIT DIÉSEL DD13 DIÉSEL	2009-2013	C/O-RING	44057HD
CASCADIA	DETROIT DIÉSEL DD13 DIÉSEL	2014-2018	C/O-RING	44057HD
CASCADIA	DETROIT DIÉSEL DD15 DIÉSEL	2008-2013	C/O-RING	44057HD
CASCADIA	DETROIT DIÉSEL DD15 DIÉSEL	2014-2016	C/O-RING	44057HD
CASCADIA	DETROIT DIÉSEL DD16 DIÉSEL	2010-2019	C/O-RING	44057HD
CENTURY CLASS	CATERPILLAR 3406 DIÉSEL	1996-1999	C/5 O-RING; C/4 JUNTAS	44054HD

FREIGHTLINER (CONTINUACIÓN)

MODELO	MOTOR	AÑOS	DESCRIPCIÓN	NO. PARTE
CENTURY CLASS	CATERPILLAR 3406 DIÉSEL	2000-2000	C/5 O-RING; C/4 JUNTAS	44054HD
CENTURY CLASS	CATERPILLAR C12 DIÉSEL	2000-2004	C/8 O-RING; C/3 JUNTAS	44060HD
CENTURY CLASS	CATERPILLAR C15 DIÉSEL	2001-2009	C/6 O-RING; C/JUNTA	44062HD
CENTURY CLASS	CUMMINS ISX DIÉSEL	2003-2003	C/2 O-RING	45051HD
CENTURY CLASS	CUMMINS M11 DIÉSEL	1996-1997	C/3 O-RING; C/2 JUNTAS	43307HD
CENTURY CLASS	CUMMINS N14 DIÉSEL	1996-2003	C/O-RING; C/2 JUNTAS	44052HD
CENTURY CLASS	DETROIT DIÉSEL 6 CIL. 11.1 L DIÉSEL	1996-2003	C/2 O-RING	44066HD
CENTURY CLASS	DETROIT DIÉSEL 6 CIL. 11.1 L DIÉSEL	1996-2003	C/2 O-RING	46002HD
CENTURY CLASS	DETROIT DIÉSEL 6 CIL. 12.7 L DIÉSEL	1996-2007	C/2 O-RING	44066HD
CENTURY CLASS	DETROIT DIÉSEL 6 CIL. 12.7 L DIÉSEL	1996-2007	C/2 O-RING	46002HD
CENTURY CLASS	DETROIT DIÉSEL 6 CIL. 14.0 L DIÉSEL	2003-2007	C/2 O-RING	44066HD
CENTURY CLASS	DETROIT DIÉSEL 6 CIL. 14.0 L DIÉSEL	2003-2007	C/2 O-RING	46002HD
CENTURY CLASS	DETROIT DIÉSEL DD15 DIÉSEL	2008-2011	C/O-RING	44057HD
CENTURY CLASS	DETROIT DIÉSEL SERIES 55 DIÉSEL	1996-1998	C/2 O-RING	44066HD
CENTURY CLASS	DETROIT DIÉSEL SERIES 55 DIÉSEL	1996-1998	C/2 O-RING	46002HD
CENTURY CLASS	CATERPILLAR C13 DIÉSEL	2004-2007	C/O-RING	43564HD
CLASS M2	CUMMINS ISC DIÉSEL	2004-2008	C/O-RING	42146HD
CLASSIC	CATERPILLAR C12 DIÉSEL	2001-2004	C/8 O-RING; C/3 JUNTAS	44060HD
CLASSIC	CATERPILLAR C15 DIÉSEL	2001-2009	C/6 O-RING; C/JUNTA	44062HD
CLASSIC	CATERPILLAR C16 DIÉSEL	2001-2003	C/3 O-RING; C/JUNTA	44051HD
CLASSIC	CUMMINS N14 DIÉSEL	2001-2002	C/O-RING; C/2 JUNTAS	44052HD
CLASSIC	DETROIT DIÉSEL 6 CIL. 11.1 L DIÉSEL	2001-2002	C/2 O-RING	44066HD
CLASSIC	DETROIT DIÉSEL 6 CIL. 11.1 L DIÉSEL	2001-2002	C/2 O-RING	46002HD
CLASSIC	DETROIT DIÉSEL 6 CIL. 12.7 L DIÉSEL	2001-2007	C/2 O-RING	44066HD
CLASSIC	DETROIT DIÉSEL 6 CIL. 12.7 L DIÉSEL	2001-2007	C/2 O-RING	46002HD
CLASSIC	DETROIT DIÉSEL 6 CIL. 14.0 L DIÉSEL	2003-2007	C/2 O-RING	44066HD
CLASSIC	DETROIT DIÉSEL 6 CIL. 14.0 L DIÉSEL	2003-2007	C/2 O-RING	46002HD
CLASSIC	CATERPILLAR C13 DIÉSEL	2004-2007	C/O-RING	43564HD
CLASSIC XL	CATERPILLAR C12 DIÉSEL	2001-2003	C/8 O-RING; C/3 JUNTAS	44060HD
CLASSIC XL	CATERPILLAR C15 DIÉSEL	2001-2009	C/6 O-RING; C/JUNTA	44062HD
CLASSIC XL	CATERPILLAR C16 DIÉSEL	2001-2003	C/3 O-RING; C/JUNTA	44051HD
CLASSIC XL	CUMMINS N14 DIÉSEL	2001-2003	C/O-RING; C/2 JUNTAS	44052HD
CLASSIC XL	DETROIT DIÉSEL 6 CIL. 11.1 L DIÉSEL	2001-2002	C/2 O-RING	44066HD
CLASSIC XL	DETROIT DIÉSEL 6 CIL. 11.1 L DIÉSEL	2001-2002	C/2 O-RING	46002HD
CLASSIC XL	DETROIT DIÉSEL 6 CIL. 12.7 L DIÉSEL	2001-2007	C/2 O-RING	44066HD
CLASSIC XL	DETROIT DIÉSEL 6 CIL. 12.7 L DIÉSEL	2001-2007	C/2 O-RING	46002HD
CLASSIC XL	DETROIT DIÉSEL 6 CIL. 14.0 L DIÉSEL	2001-2007	C/2 O-RING	44066HD
CLASSIC XL	DETROIT DIÉSEL 6 CIL. 14.0 L DIÉSEL	2001-2007	C/2 O-RING	46002HD
CLASSIC XL	CATERPILLAR C13 DIÉSEL	2004-2007	C/O-RING	43564HD
COLUMBIA	CATERPILLAR C10 DIÉSEL	2001-2001	C/8 O-RING; C/3 JUNTAS	44060HD
COLUMBIA	CATERPILLAR C12 DIÉSEL	2001-2004	C/8 O-RING; C/3 JUNTAS	44060HD
COLUMBIA	CATERPILLAR C15 DIÉSEL	2001-2009	C/6 O-RING; C/JUNTA	44062HD
COLUMBIA	CATERPILLAR C16 DIÉSEL	2001-2004	C/3 O-RING; C/JUNTA	44051HD
COLUMBIA	CUMMINS ISM DIÉSEL	2002-2007	C/6 O-RING; C/JUNTA	45055HD
COLUMBIA	CUMMINS ISX DIÉSEL	2002-2003	C/2 O-RING	45051HD
COLUMBIA	CUMMINS N14 DIÉSEL	2001-2009	C/O-RING; C/2 JUNTAS	44052HD
COLUMBIA	DETROIT DIÉSEL 6 CIL. 11.1 L DIÉSEL	2000-2001	C/2 O-RING	44066HD

FREIGHTLINER (CONTINUACIÓN)

MODELO	MOTOR	AÑOS	DESCRIPCIÓN	NO. PARTE
COLUMBIA	DETROIT DIÉSEL 6 CIL. 11.1 L DIÉSEL	2000-2001	C/2 O-RING	46002HD
COLUMBIA	DETROIT DIÉSEL 6 CIL. 12.7 L DIÉSEL	2000-2008	C/2 O-RING	44066HD
COLUMBIA	DETROIT DIÉSEL 6 CIL. 12.7 L DIÉSEL	2000-2008	C/2 O-RING	46002HD
COLUMBIA	DETROIT DIÉSEL 6 CIL. 12.7 L DIÉSEL	2005-2005	C/2 O-RING	46003HD
COLUMBIA	DETROIT DIÉSEL 6 CIL. 14.0 L DIÉSEL	2002-2007	C/2 O-RING	44066HD
COLUMBIA	DETROIT DIÉSEL 6 CIL. 14.0 L DIÉSEL	2002-2007	C/2 O-RING	46002HD
COLUMBIA	DETROIT DIÉSEL 6 CIL. 14.0 L DIÉSEL	2005-2005	C/2 O-RING	46003HD
COLUMBIA	DETROIT DIÉSEL DD13 DIÉSEL	2010-2011	C/O-RING	44057HD
COLUMBIA	DETROIT DIÉSEL DD15 DIÉSEL	2008-2011	C/O-RING	44057HD
COLUMBIA	CATERPILLAR C11 DIÉSEL	2004-2007	C/O-RING	43564HD
COLUMBIA	CATERPILLAR C13 DIÉSEL	2004-2009	C/O-RING	43564HD
CONDOR	CATERPILLAR C10 DIÉSEL	2001-2001	C/8 O-RING; C/3 JUNTAS	44060HD
CONDOR	CATERPILLAR C12 DIÉSEL	2001-2005	C/8 O-RING; C/3 JUNTAS	44060HD
CONDOR	CATERPILLAR C7 DIÉSEL	2004-2005	C/O-RING	43561HD
CONDOR	CUMMINS ISC DIÉSEL	2001-2006	C/O-RING	42146HD
CONDOR	CUMMINS ISL DIÉSEL	2001-2007	C/O-RING	42146HD
CONDOR	CUMMINS ISM DIÉSEL	2001-2003	C/6 O-RING; C/JUNTA	45055HD
CONDOR	CATERPILLAR C11 DIÉSEL	2005-2006	C/O-RING	43564HD
CONDOR	CATERPILLAR C13 DIÉSEL	2004-2006	C/O-RING	43564HD
CORONADO	CATERPILLAR C15 DIÉSEL	2001-2009	C/6 O-RING; C/JUNTA	44062HD
CORONADO	CATERPILLAR C16 DIÉSEL	2002-2003	C/3 O-RING; C/JUNTA	44051HD
CORONADO	CUMMINS ISX15 DIÉSEL	2010-2016	C/2 O-RING	45052HD
CORONADO	DETROIT DIÉSEL 6 CIL. 12.7 L DIÉSEL	2002-2009	C/2 O-RING	44066HD
CORONADO	DETROIT DIÉSEL 6 CIL. 12.7 L DIÉSEL	2002-2009	C/2 O-RING	46002HD
CORONADO	DETROIT DIÉSEL 6 CIL. 14.0 L DIÉSEL	2003-2007	C/2 O-RING	44066HD
CORONADO	DETROIT DIÉSEL 6 CIL. 14.0 L DIÉSEL	2003-2007	C/2 O-RING	46002HD
CORONADO	DETROIT DIÉSEL DD13 DIÉSEL	2010-2016	C/O-RING	44057HD
CORONADO	DETROIT DIÉSEL DD15 DIÉSEL	2010-2016	C/O-RING	44057HD
CORONADO	DETROIT DIÉSEL DD16 DIÉSEL	2010-2016	C/O-RING	44057HD
FL106	DETROIT DIÉSEL SERIES 50 DIÉSEL	1994-2001	C/2 O-RING	44066HD
FL106	DETROIT DIÉSEL SERIES 50 DIÉSEL	1994-2001	C/2 O-RING	46002HD
FL112	CATERPILLAR C12 DIÉSEL	2000-2003	C/8 O-RING; C/3 JUNTAS	44060HD
FL112	CUMMINS ISM DIÉSEL	2001-2002	C/6 O-RING; C/JUNTA	45055HD
FL112	DETROIT DIÉSEL SERIES 55 DIÉSEL	1997-1998	C/2 O-RING	44066HD
FL112	DETROIT DIÉSEL SERIES 55 DIÉSEL	1997-1998	C/2 O-RING	46002HD
FL50	CATERPILLAR 3126 DIÉSEL	2004-2004	C/2 O-RING	43554HD
FL50	CATERPILLAR C7 DIÉSEL	2004-2004	C/O-RING	43561HD
FL50	CUMMINS B SERIES 5.9 L DIÉSEL	1995-1997	C/O-RING	41181
FL50	CUMMINS C SERIES 8.3 L DIÉSEL	1995-1996	C/O-RING	42352HD
FL50	CUMMINS ISB DIÉSEL	1998-1998	C/O-RING	41181
FL50	CUMMINS ISC DIÉSEL	1998-2005	C/O-RING	42146HD
FL60	CATERPILLAR 3126 DIÉSEL	2002-2002	C/2 O-RING	43554HD
FL60	CATERPILLAR 3126 DIÉSEL	2004-2004	C/2 O-RING	43554HD
FL60	CATERPILLAR C7 DIÉSEL	2004-2005	C/O-RING	43561HD
FL60	CUMMINS B SERIES 5.9 L DIÉSEL	1991-1997	C/O-RING	41181
FL60	CUMMINS C SERIES 8.3 L DIÉSEL	1994-1996	C/O-RING	42352HD
FL60	CUMMINS ISB DIÉSEL	1998-1998	C/O-RING	41181

FREIGHTLINER (CONTINUACIÓN)

MODELO	MOTOR	AÑOS	DESCRIPCIÓN	NO. PARTE
FL60	CUMMINS ISC DIÉSEL	1998-2004	C/O-RING	42146HD
FL60	MERCEDES-BENZ MBE 900 DIÉSEL	2001-2004	C/O-RING; C/JUNTA	45053HD
FL70	CATERPILLAR 3126 DIÉSEL	1998-2004	C/2 O-RING	43554HD
FL70	CATERPILLAR C7 DIÉSEL	2004-2005	C/O-RING	43561HD
FL70	CUMMINS B SERIES 5.9 L DIÉSEL	1991-1997	C/O-RING	41181
FL70	CUMMINS C SERIES 8.3 L DIÉSEL	1994-1996	C/O-RING	42352HD
FL70	CUMMINS ISB DIÉSEL	1998-1998	C/O-RING	41181
FL70	CUMMINS ISC DIÉSEL	1998-2005	C/O-RING	42146HD
FL70	MERCEDES-BENZ MBE 900 DIÉSEL	2001-2001	C/O-RING; C/JUNTA	45053HD
FL70	MERCEDES-BENZ MBE 900 DIÉSEL	2003-2005	C/O-RING; C/JUNTA	45050HD
FL80	CATERPILLAR 3126 DIÉSEL	2004-2004	C/2 O-RING	43554HD
FL80	CATERPILLAR C7 DIÉSEL	2004-2005	C/O-RING	43561HD
FL80	CUMMINS B SERIES 5.9 L DIÉSEL	1991-1997	C/O-RING	41181
FL80	CUMMINS C SERIES 8.3 L DIÉSEL	1994-1996	C/O-RING	42352HD
FL80	CUMMINS ISB DIÉSEL	1998-1998	C/O-RING	41181
FL80	CUMMINS ISC DIÉSEL	1998-2005	C/O-RING	42146HD
FL80	CUMMINS ISC DIÉSEL	2000-2001	C/O-RING	43566HD
FL80	MERCEDES-BENZ MBE 900 DIÉSEL	2000-2005	C/O-RING; C/JUNTA	45053HD
FLA	CATERPILLAR 3406 DIÉSEL	1993-1994	C/5 O-RING; C/4 JUNTAS	44054HD
FLA	CUMMINS 6 CIL. 14.0 L DIÉSEL	1989-1989	C/O-RING; C/2 JUNTAS	44092HD
FLA	CUMMINS 6 CIL. 14.0 L DIÉSEL	1990-1990	C/O-RING; C/2 JUNTAS	44052HD
FLA	CUMMINS L10 DIÉSEL	1991-1994	POLEA LOCA DE BA 43307HD	41175HD
FLA	CUMMINS L10 DIÉSEL	1991-1994	C/3 O-RING; C/2 JUNTAS	43307HD
FLA	CUMMINS N14 DIÉSEL	1991-1994	C/O-RING; C/2 JUNTAS	44052HD
FLA	DETROIT DIÉSEL 6 CIL. 11.1 L	1989-1990	C/2 O-RING	46005HD
FLA	DETROIT DIÉSEL 6 CIL. 11.1 L DIÉSEL	1991-1994	C/2 O-RING	44066HD
FLA	DETROIT DIÉSEL 6 CIL. 11.1 L DIÉSEL	1991-1994	C/2 O-RING	46002HD
FLA	DETROIT DIÉSEL 6 CIL. 12.7 L	1989-1990	C/2 O-RING	46005HD
FLA	DETROIT DIÉSEL 6 CIL. 12.7 L DIÉSEL	1991-1994	C/2 O-RING	44066HD
FLA	DETROIT DIÉSEL 6 CIL. 12.7 L DIÉSEL	1991-1994	C/2 O-RING	46002HD
FLB	CATERPILLAR 3406 DIÉSEL	1994-1997	C/5 O-RING; C/4 JUNTAS	44054HD
FLB	CUMMINS ISC DIÉSEL	1998-1998	C/O-RING	42146HD
FLB	CUMMINS L10 DIÉSEL	1995-1996	POLEA LOCA DE BA 43307HD	41175HD
FLB	CUMMINS L10 DIÉSEL	1995-1996	C/3 O-RING; C/2 JUNTAS	43307HD
FLB	CUMMINS M11 DIÉSEL	1995-1998	C/3 O-RING; C/2 JUNTAS	43307HD
FLB	CUMMINS N14 DIÉSEL	1994-1999	C/O-RING; C/2 JUNTAS	44052HD
FLB	DETROIT DIÉSEL 6 CIL. 11.1 L DIÉSEL	1994-1999	C/2 O-RING	44066HD
FLB	DETROIT DIÉSEL 6 CIL. 11.1 L DIÉSEL	1994-1999	C/2 O-RING	46002HD
FLB	DETROIT DIÉSEL 6 CIL. 12.7 L DIÉSEL	1994-1999	C/2 O-RING	44066HD
FLB	DETROIT DIÉSEL 6 CIL. 12.7 L DIÉSEL	1994-1999	C/2 O-RING	46002HD
FLC	CATERPILLAR 3406 DIÉSEL	1993-1996	C/5 O-RING; C/4 JUNTAS	44054HD
FLC	CUMMINS 6 CIL. 14.0 L DIÉSEL	1980-1981		41111HD
FLC	CUMMINS 6 CIL. 14.0 L DIÉSEL	1985-1985		41111HD
FLC	CUMMINS 6 CIL. 14.0 L DIÉSEL	1985-1985	C/O-RING; C/2 JUNTAS	44092HD
FLC	CUMMINS 6 CIL. 14.0 L DIÉSEL	1986-1989	C/O-RING; C/2 JUNTAS	44092HD
FLC	CUMMINS 6 CIL. 14.0 L DIÉSEL	1990-1990	C/O-RING; C/2 JUNTAS	44052HD
FLC	CUMMINS C SERIES 8.3 L DIÉSEL	1995-1997	C/O-RING	42352HD

FREIGHTLINER (CONTINUACIÓN)

MODELO	MOTOR	AÑOS	DESCRIPCIÓN	NO. PARTE
FLC	CUMMINS L10 DIÉSEL	1991-1996	POLEA LOCA DE BA 43307HD	41175HD
FLC	CUMMINS L10 DIÉSEL	1991-1996	C/3 O-RING; C/2 JUNTAS	43307HD
FLC	CUMMINS M11 DIÉSEL	1995-1998	C/3 O-RING; C/2 JUNTAS	43307HD
FLC	CUMMINS N14 DIÉSEL	1991-1998	C/O-RING; C/2 JUNTAS	44052HD
FLC	DETROIT DIÉSEL 6 CIL. 11.1 L	1987-1990	C/2 O-RING	46005HD
FLC	DETROIT DIÉSEL 6 CIL. 11.1 L DIÉSEL	1991-2000	C/2 O-RING	44066HD
FLC	DETROIT DIÉSEL 6 CIL. 11.1 L DIÉSEL	1991-2000	C/2 O-RING	46002HD
FLC	DETROIT DIÉSEL 6 CIL. 12.7 L	1987-1990	C/2 O-RING	46005HD
FLC	DETROIT DIÉSEL 6 CIL. 12.7 L DIÉSEL	1991-1998	C/2 O-RING	44066HD
FLC	DETROIT DIÉSEL 6 CIL. 12.7 L DIÉSEL	1991-1998	C/2 O-RING	46002HD
FLD	CATERPILLAR 3406 DIÉSEL	1993-2000	C/5 O-RING; C/4 JUNTAS	44054HD
FLD	CATERPILLAR 3406 DIÉSEL	1996-1999	C/5 O-RING; C/4 JUNTAS	44054HD
FLD	CATERPILLAR C10 DIÉSEL	2000-2000	C/8 O-RING; C/3 JUNTAS	44060HD
FLD	CATERPILLAR C12 DIÉSEL	2000-2004	C/8 O-RING; C/3 JUNTAS	44060HD
FLD	CATERPILLAR C15 DIÉSEL	2000-2010	C/6 O-RING; C/JUNTA	44062HD
FLD	CATERPILLAR C16 DIÉSEL	2000-2004	C/3 O-RING; C/JUNTA	44051HD
FLD	CUMMINS 6 CIL. 14.0 L DIÉSEL	1988-1989	C/O-RING; C/2 JUNTAS	44092HD
FLD	CUMMINS 6 CIL. 14.0 L DIÉSEL	1990-1990	C/O-RING; C/2 JUNTAS	44052HD
FLD	CUMMINS C SERIES 8.3 L DIÉSEL	1995-1996	C/O-RING	42352HD
FLD	CUMMINS ISC DIÉSEL	1998-2002	C/O-RING	42146HD
FLD	CUMMINS ISM DIÉSEL	1998-1998	C/3 O-RING; C/2 JUNTAS	43307HD
FLD	CUMMINS ISM DIÉSEL	1999-2002	C/6 O-RING; C/JUNTA	45055HD
FLD	CUMMINS L10 DIÉSEL	1991-1996	POLEA LOCA DE BA 43307HD	41175HD
FLD	CUMMINS L10 DIÉSEL	1991-1996	C/3 O-RING; C/2 JUNTAS	43307HD
FLD	CUMMINS M11 DIÉSEL	1995-1997	C/3 O-RING; C/2 JUNTAS	43307HD
FLD	CUMMINS N14 DIÉSEL	1991-2008	C/O-RING; C/2 JUNTAS	44052HD
FLD	DETROIT DIÉSEL 6 CIL. 11.1 L	1988-1990	C/2 O-RING	46005HD
FLD	DETROIT DIÉSEL 6 CIL. 11.1 L DIÉSEL	1991-2002	C/2 O-RING	44066HD
FLD	DETROIT DIÉSEL 6 CIL. 11.1 L DIÉSEL	1991-2002	C/2 O-RING	46002HD
FLD	DETROIT DIÉSEL 6 CIL. 12.7 L	1988-1990	C/2 O-RING	46005HD
FLD	DETROIT DIÉSEL 6 CIL. 12.7 L DIÉSEL	1991-2008	C/2 O-RING	44066HD
FLD	DETROIT DIÉSEL 6 CIL. 12.7 L DIÉSEL	1991-2008	C/2 O-RING	46002HD
FLD	DETROIT DIÉSEL 6 CIL. 14.0 L DIÉSEL	2001-2007	C/2 O-RING	44066HD
FLD	DETROIT DIÉSEL 6 CIL. 14.0 L DIÉSEL	2001-2007	C/2 O-RING	46002HD
FLD	DETROIT DIÉSEL SERIES 50 DIÉSEL	1994-1996	C/2 O-RING	44066HD
FLD	DETROIT DIÉSEL SERIES 50 DIÉSEL	1994-1996	C/2 O-RING	46002HD
FLD	MERCEDES-BENZ MBE 4000 DIÉSEL	2005-2006	C/O-RING; C/JUNTA	45050HD
FLD	CATERPILLAR C11 DIÉSEL	2004-2007	C/O-RING	43564HD
FLD	CATERPILLAR C13 DIÉSEL	2004-2007	C/O-RING	43564HD
FLL	CATERPILLAR 3406 DIÉSEL	1995-1996	C/5 O-RING; C/4 JUNTAS	44054HD
FLL	CATERPILLAR 3406 DIÉSEL	1997-1997	C/5 O-RING; C/4 JUNTAS	44054HD
FLL	CUMMINS L10 DIÉSEL	1989-1996	POLEA LOCA DE BA 43307HD	41175HD
FLL	CUMMINS N14 DIÉSEL	1995-1998	C/O-RING; C/2 JUNTAS	44052HD
FLL	DETROIT DIÉSEL 6 CIL. 11.1 L DIÉSEL	1995-1998	C/2 O-RING	44066HD
FLL	DETROIT DIÉSEL 6 CIL. 11.1 L DIÉSEL	1995-1998	C/2 O-RING	46002HD
FLL	DETROIT DIÉSEL 6 CIL. 12.7 L DIÉSEL	1990-1998	C/2 O-RING	44066HD
FLL	DETROIT DIÉSEL 6 CIL. 12.7 L DIÉSEL	1990-1998	C/2 O-RING	46002HD

FREIGHTLINER (CONTINUACIÓN)

MODELO	MOTOR	AÑOS	DESCRIPCIÓN	NO. PARTE
FLS112	DETROIT DIÉSEL 6 CIL. 11.1 L DIÉSEL	2000-2000	C/2 O-RING	44066HD
FLS112	DETROIT DIÉSEL 6 CIL. 11.1 L DIÉSEL	2000-2000	C/2 O-RING	46002HD
FLS112	DETROIT DIÉSEL 6 CIL. 12.7 L DIÉSEL	2000-2000	C/2 O-RING	44066HD
FLS112	DETROIT DIÉSEL 6 CIL. 12.7 L DIÉSEL	2000-2000	C/2 O-RING	46002HD
FLT	CUMMINS 6 CIL. 14.0 L DIÉSEL	1980-1981		41111HD
FLT	CUMMINS 6 CIL. 14.0 L DIÉSEL	1985-1985		41111HD
FLT	CUMMINS 6 CIL. 14.0 L DIÉSEL	1985-1985	C/O-RING; C/2 JUNTAS	44092HD
FLT	CUMMINS 6 CIL. 14.0 L DIÉSEL	1986-1988	C/O-RING; C/2 JUNTAS	44092HD
FLT	DETROIT DIÉSEL 6 CIL. 11.1 L	1987-1988	C/2 O-RING	46005HD
FLT	DETROIT DIÉSEL 6 CIL. 12.7 L	1987-1988	C/2 O-RING	46005HD
FS65	CATERPILLAR 3126 DIÉSEL	2003-2004	C/2 O-RING	43554HD
FS65	MERCEDES-BENZ MBE 900 DIÉSEL	2005-2005	C/O-RING; C/JUNTA	45050HD
MT35	CUMMINS 4 CIL. 3.9 L DIÉSEL	1997-2001	C/O-RING	41181
MT35	CUMMINS 4 CIL. 3.9 L DIÉSEL	2002-2003	C/O-RING	42291
MT35	CUMMINS ISB DIÉSEL	2004-2005	C/O-RING	42291
MT45	CUMMINS ISB DIÉSEL	2005-2010	C/O-RING	42291
MT45	CUMMINS ISB DIÉSEL	2008-2009	C/JUNTA	41199HD
MT55	CUMMINS ISB DIÉSEL	2004-2004	C/O-RING	42291
MT55	CUMMINS ISB DIÉSEL	2008-2009	C/JUNTA	41199HD
MT55	CUMMINS ISB DIÉSEL	2010-2010	C/O-RING	41181

INTERNATIONAL/NAVISTAR

MODELO	MOTOR	AÑOS	DESCRIPCIÓN	NO. PARTE
1654	NAVISTAR V8, 9.0 L DIÉSEL	1980-1982	C/O-RING	42114HD
1754	NAVISTAR V8, 9.0 L DIÉSEL	1980-1988	C/O-RING	42114HD
1854	NAVISTAR V8, 9.0 L DIÉSEL	1980-1988	C/O-RING	42114HD
1954	NAVISTAR V8, 9.0 L DIÉSEL	1980-1984	C/O-RING	42114HD
1955	NAVISTAR V8, 9.0 L DIÉSEL	1980-1982	C/O-RING	42114HD
2155	NAVISTAR V8, 9.0 L DIÉSEL	1980-1980	C/O-RING	42114HD
2275	NAVISTAR V8, 9.0 L DIÉSEL	1980-1980	C/O-RING	42114HD
2554	CATERPILLAR C12 DIÉSEL	2003-2003	C/8 O-RING; C/3 JUNTAS	44060HD
2554	CUMMINS N14 DIÉSEL	1999-2000	C/O-RING; C/2 JUNTAS	44052HD
2554	NAVISTAR 530 DIÉSEL	1995-2002	C/O-RING	42318HD
2554	NAVISTAR DT466 DIÉSEL	1986-1990	C/JUNTA	44058HD
2554	NAVISTAR DT466 DIÉSEL	1991-1991	C/JUNTA	44058HD
2554	NAVISTAR DT466 DIÉSEL	1991-1991	C/JUNTA	44059HD
2554	NAVISTAR DT466 DIÉSEL	1992-1995	C/JUNTA	44059HD
2554	NAVISTAR DT466 DIÉSEL	1996-2002	C/O-RING	42318HD
2574	CATERPILLAR C10 DIÉSEL	2001-2001	C/8 O-RING; C/3 JUNTAS	44060HD
2574	CATERPILLAR C12 DIÉSEL	1999-2003	C/8 O-RING; C/3 JUNTAS	44060HD
2574	CUMMINS 6 CIL. 14.0 L DIÉSEL	1985-1985	C/O-RING; C/2 JUNTAS	44092HD
2574	CUMMINS 6 CIL. 14.0 L DIÉSEL	1986-1989	C/O-RING; C/2 JUNTAS	44092HD
2574	CUMMINS 6 CIL. 14.0 L DIÉSEL	1990-1990	C/O-RING; C/2 JUNTAS	44052HD
2574	CUMMINS N14 DIÉSEL	1991-2000	C/O-RING; C/2 JUNTAS	44052HD
2574	NAVISTAR 530 DIÉSEL	1994-2003	C/O-RING	42318HD
2574	NAVISTAR DT466 DIÉSEL	2001-2002	C/O-RING	42318HD
2654	CATERPILLAR C12 DIÉSEL	2003-2003	C/8 O-RING; C/3 JUNTAS	44060HD

INTERNATIONAL/NAVISTAR (CONTINUACIÓN)

MODELO	MOTOR	AÑOS	DESCRIPCIÓN	NO. PARTE
2654	CUMMINS N14 DIÉSEL	1999-2000	C/O-RING; C/2 JUNTAS	44052HD
2654	NAVISTAR 530 DIÉSEL	1995-2002	C/O-RING	42318HD
2654	NAVISTAR DT466 DIÉSEL	1989-1991	C/JUNTA	44058HD
2654	NAVISTAR DT466 DIÉSEL	1992-1993	C/JUNTA	44058HD
2654	NAVISTAR DT466 DIÉSEL	1992-1993	C/JUNTA	44059HD
2654	NAVISTAR DT466 DIÉSEL	1994-2002	C/O-RING	42318HD
2674	CATERPILLAR C12 DIÉSEL	1999-2003	C/8 O-RING; C/3 JUNTAS	44060HD
2674	CUMMINS 6 CIL. 14.0 L DIÉSEL	1985-1985	C/O-RING; C/2 JUNTAS	44092HD
2674	CUMMINS 6 CIL. 14.0 L DIÉSEL	1986-1989	C/O-RING; C/2 JUNTAS	44092HD
2674	CUMMINS 6 CIL. 14.0 L DIÉSEL	1990-1990	C/O-RING; C/2 JUNTAS	44052HD
2674	CUMMINS ISM DIÉSEL	2003-2003	C/3 O-RING; C/2 JUNTAS	43307HD
2674	CUMMINS L10 DIÉSEL	1991-1998	C/3 O-RING; C/2 JUNTAS	43307HD
2674	CUMMINS M11 DIÉSEL	1994-1997	C/3 O-RING; C/2 JUNTAS	43307HD
2674	CUMMINS N14 DIÉSEL	1991-2002	C/O-RING; C/2 JUNTAS	44052HD
2674	NAVISTAR 530 DIÉSEL	1994-2003	C/O-RING	42318HD
2674	NAVISTAR DT466 DIÉSEL	2001-2003	C/O-RING	42318HD
3600	NAVISTAR DT466 DIÉSEL	1993-1994	C/JUNTA	44059HD
3700	NAVISTAR DT466 DIÉSEL	1993-1994	C/JUNTA	44059HD
3800	NAVISTAR DT360 DIÉSEL	1990-1990	C/JUNTA	44058HD
3800	NAVISTAR DT466 DIÉSEL	1993-1994	C/JUNTA	44059HD
3800	NAVISTAR T444 DIÉSEL	2000-2004	C/JUNTA DE GOMA	43545HD
4300	NAVISTAR DT466 DIÉSEL	2002-2002	C/O-RING	42318HD
4300	NAVISTAR DT466 DIÉSEL	2002-2007	C/O-RING	43325HD
4300	NAVISTAR MAXXFORCE DT DIÉSEL	2008-2008	C/O-RING	43325HD
4400	NAVISTAR 530 DIÉSEL	2002-2005	C/O-RING	42318HD
4400	NAVISTAR DT466 DIÉSEL	2002-2005	C/O-RING	42318HD
4400	NAVISTAR DT466 DIÉSEL	2002-2007	C/O-RING	43325HD
4400	NAVISTAR DT570 DIÉSEL	2006-2007	C/O-RING	43325HD
4400	NAVISTAR MAXXFORCE 9 DIÉSEL	2008-2008	C/O-RING	43325HD
4400	NAVISTAR MAXXFORCE DT DIÉSEL	2008-2008	C/O-RING	43325HD
4700	NAVISTAR 530 DIÉSEL	1997-2003	C/O-RING	42318HD
4700	NAVISTAR DT360 DIÉSEL	1990-1994	C/JUNTA	44058HD
4700	NAVISTAR DT360 DIÉSEL	1990-1994	C/JUNTA	44059HD
4700	NAVISTAR DT408 DIÉSEL	1994-1997	C/O-RING	42318HD
4700	NAVISTAR DT466 DIÉSEL	1994-1994	C/JUNTA	44059HD
4700	NAVISTAR DT466 DIÉSEL	1995-2002	C/O-RING	42318HD
4700	NAVISTAR DT466 DIÉSEL	2002-2002	C/O-RING	43325HD
4700	NAVISTAR T444 DIÉSEL	1996-2001	C/JUNTA DE GOMA	43545HD
4800	NAVISTAR 530 DIÉSEL	1996-2002	C/O-RING	42318HD
4800	NAVISTAR DT360 DIÉSEL	1990-1994	C/JUNTA	44058HD
4800	NAVISTAR DT360 DIÉSEL	1990-1994	C/JUNTA	44059HD
4800	NAVISTAR DT408 DIÉSEL	1994-1997	C/O-RING	42318HD
4800	NAVISTAR DT466 DIÉSEL	1990-1990	C/JUNTA	44058HD
4800	NAVISTAR DT466 DIÉSEL	1991-1992	C/JUNTA	44058HD
4800	NAVISTAR DT466 DIÉSEL	1991-1992	C/JUNTA	44059HD
4800	NAVISTAR DT466 DIÉSEL	1993-1994	C/JUNTA	44059HD
4800	NAVISTAR DT466 DIÉSEL	1995-2003	C/O-RING	42318HD

INTERNATIONAL/NAVISTAR (CONTINUACIÓN)

MODELO	MOTOR	AÑOS	DESCRIPCIÓN	NO. PARTE
4800	NAVISTAR DT466 DIÉSEL	2002-2002	C/O-RING	43325HD
4800	NAVISTAR T444 DIÉSEL	1997-1997	C/JUNTA DE GOMA	43545HD
4900	NAVISTAR 530 DIÉSEL	1994-2003	C/O-RING	42318HD
4900	NAVISTAR DT360 DIÉSEL	1993-1993	C/JUNTA	44058HD
4900	NAVISTAR DT360 DIÉSEL	1993-1993	C/JUNTA	44059HD
4900	NAVISTAR DT408 DIÉSEL	1994-1997	C/O-RING	42318HD
4900	NAVISTAR DT466 DIÉSEL	1990-1991	C/JUNTA	44058HD
4900	NAVISTAR DT466 DIÉSEL	1992-1992	C/JUNTA	44058HD
4900	NAVISTAR DT466 DIÉSEL	1992-1992	C/JUNTA	44059HD
4900	NAVISTAR DT466 DIÉSEL	1993-1994	C/JUNTA	44059HD
4900	NAVISTAR DT466 DIÉSEL	1995-2003	C/O-RING	42318HD
4900	NAVISTAR T444 DIÉSEL	1997-1997	C/JUNTA DE GOMA	43545HD
5000	CATERPILLAR 3406 DIÉSEL	1996-1996	C/5 O-RING; C/4 JUNTAS	44054HD
5000	CUMMINS 6 CIL. 14.0 L DIÉSEL	1990-1990	C/O-RING; C/2 JUNTAS	44052HD
5000	CUMMINS L10 DIÉSEL	1991-1998	POLEA LOCA DE BA 43307HD	41175HD
5000	CUMMINS N14 DIÉSEL	1991-1999	C/O-RING; C/2 JUNTAS	44052HD
5500I	CATERPILLAR C12 DIÉSEL	2000-2004	C/8 O-RING; C/3 JUNTAS	44060HD
5500I	CATERPILLAR C15 DIÉSEL	2006-2007	C/6 O-RING; C/JUNTA	44062HD
5500I	CUMMINS ISL DIÉSEL	2007-2007	C/2 O-RING	45052HD
5500I	CUMMINS ISM DIÉSEL	2000-2007	C/3 O-RING; C/2 JUNTAS	43307HD
5500I	CUMMINS ISX DIÉSEL	2003-2007	C/2 O-RING	45054HD
5500I	CUMMINS N14 DIÉSEL	2000-2003	C/O-RING; C/2 JUNTAS	44052HD
5500I	CATERPILLAR C13 DIÉSEL	2005-2007	C/O-RING	43564HD
5600I	CATERPILLAR C12 DIÉSEL	2000-2004	C/8 O-RING; C/3 JUNTAS	44060HD
5600I	CATERPILLAR C15 DIÉSEL	2004-2007	C/6 O-RING; C/JUNTA	44062HD
5600I	CUMMINS ISX DIÉSEL	2003-2007	C/2 O-RING	45054HD
5600I	CUMMINS N14 DIÉSEL	2000-2003	C/O-RING; C/2 JUNTAS	44052HD
5600I	NAVISTAR 530 DIÉSEL	2000-2005	C/O-RING	42318HD
5600I	CATERPILLAR C13 DIÉSEL	2005-2007	C/O-RING	43564HD
5900I	CATERPILLAR 3406 DIÉSEL	2003-2003	C/3 O-RING; C/JUNTA	44051HD
5900I	CATERPILLAR C12 DIÉSEL	2000-2004	C/8 O-RING; C/3 JUNTAS	44060HD
5900I	CATERPILLAR C15 DIÉSEL	2004-2007	C/6 O-RING; C/JUNTA	44062HD
5900I	CUMMINS ISX DIÉSEL	2003-2007	C/2 O-RING	45054HD
5900I	CUMMINS N14 DIÉSEL	2000-2003	C/O-RING; C/2 JUNTAS	44052HD
5900I	CATERPILLAR C13 DIÉSEL	2005-2007	C/O-RING	43564HD
7100	NAVISTAR 530 DIÉSEL	1994-1994	C/O-RING	42318HD
7100	NAVISTAR DT466 DIÉSEL	1990-1990	C/JUNTA	44058HD
7100	NAVISTAR DT466 DIÉSEL	1991-1995	C/JUNTA	44058HD
7100	NAVISTAR DT466 DIÉSEL	1991-1995	C/JUNTA	44059HD
7300	NAVISTAR DT466 DIÉSEL	2002-2004	C/O-RING	42318HD
7300	NAVISTAR DT466 DIÉSEL	2005-2007	C/O-RING	43325HD
7400	NAVISTAR 530 DIÉSEL	2002-2003	C/O-RING	42318HD
7400	NAVISTAR DT466 DIÉSEL	2002-2003	C/O-RING	42318HD
7400	NAVISTAR DT466 DIÉSEL	2003-2007	C/O-RING	43325HD
7400	NAVISTAR DT570 DIÉSEL	2005-2007	C/O-RING	43325HD
7500	NAVISTAR HT570 DIÉSEL	2005-2005	C/O-RING	43325HD
7600	CATERPILLAR 3406 DIÉSEL	2003-2003	C/5 O-RING; C/4 JUNTAS	44054HD

INTERNATIONAL/NAVISTAR (CONTINUACIÓN)

MODELO	MOTOR	AÑOS	DESCRIPCIÓN	NO. PARTE
7600	CATERPILLAR C12 DIÉSEL	2002-2004	C/8 O-RING; C/3 JUNTAS	44060HD
7600	CATERPILLAR C13 DIÉSEL	2004-2007	C/O-RING	43564HD
7700	CUMMINS ISM DIÉSEL	2007-2007	C/6 O-RING; C/JUNTA	45055HD
7700	CATERPILLAR C13 DIÉSEL	2005-2007	C/O-RING	43564HD
8100	CATERPILLAR 3406 DIÉSEL	1996-1998	C/5 O-RING; C/4 JUNTAS	44054HD
8100	CUMMINS L10 DIÉSEL	1991-1997	POLEA LOCA DE BA 43307HD	41175HD
8100	CUMMINS L10 DIÉSEL	1991-1998	C/3 O-RING; C/2 JUNTAS	43307HD
8100	CUMMINS M11 DIÉSEL	1994-1997	C/3 O-RING; C/2 JUNTAS	43307HD
8100	CUMMINS N14 DIÉSEL	1995-1999	C/O-RING; C/2 JUNTAS	44052HD
8100	DETROIT DIÉSEL 6 CIL. 11.1 L DIÉSEL	1991-1996	C/2 O-RING	44066HD
8100	DETROIT DIÉSEL 6 CIL. 11.1 L DIÉSEL	1991-1996	C/2 O-RING	46002HD
8100	DETROIT DIÉSEL 6 CIL. 12.7 L DIÉSEL	1991-1996	C/2 O-RING	44066HD
8100	DETROIT DIÉSEL 6 CIL. 12.7 L DIÉSEL	1991-1996	C/2 O-RING	46002HD
8100	DETROIT DIÉSEL SERIES 50 DIÉSEL	1994-1998	C/2 O-RING	44066HD
8100	DETROIT DIÉSEL SERIES 50 DIÉSEL	1994-1998	C/2 O-RING	46002HD
8100	NAVISTAR 530 DIÉSEL	1994-2003	C/O-RING	42318HD
8100	NAVISTAR DT466 DIÉSEL	1990-1992	C/JUNTA	44058HD
8100	NAVISTAR DT466 DIÉSEL	1991-1991	C/JUNTA	44058HD
8100	NAVISTAR DT466 DIÉSEL	1991-1991	C/JUNTA	44059HD
8100	NAVISTAR DT466 DIÉSEL	1993-1994	C/JUNTA	44059HD
8100	NAVISTAR DT466 DIÉSEL	1995-2003	C/O-RING	42318HD
8200	CATERPILLAR 3406 DIÉSEL	1993-1995	C/5 O-RING; C/4 JUNTAS	44054HD
8200	CATERPILLAR 3406 DIÉSEL	1996-1998	C/5 O-RING; C/4 JUNTAS	44054HD
8200	CUMMINS 6 CIL. 14.0 L DIÉSEL	1990-1990	C/O-RING; C/2 JUNTAS	44052HD
8200	CUMMINS ISM DIÉSEL	1998-1998	C/3 O-RING; C/2 JUNTAS	43307HD
8200	CUMMINS L10 DIÉSEL	1991-1997	POLEA LOCA DE BA 43307HD	41175HD
8200	CUMMINS L10 DIÉSEL	1991-1997	C/3 O-RING; C/2 JUNTAS	43307HD
8200	CUMMINS M11 DIÉSEL	1994-1997	C/3 O-RING; C/2 JUNTAS	43307HD
8200	CUMMINS N14 DIÉSEL	1991-1998	C/O-RING; C/2 JUNTAS	44052HD
8200	DETROIT DIÉSEL 6 CIL. 11.1 L DIÉSEL	1991-1998	C/2 O-RING	44066HD
8200	DETROIT DIÉSEL 6 CIL. 11.1 L DIÉSEL	1991-1998	C/2 O-RING	46002HD
8200	DETROIT DIÉSEL 6 CIL. 12.7 L DIÉSEL	1991-1996	C/2 O-RING	44066HD
8200	DETROIT DIÉSEL 6 CIL. 12.7 L DIÉSEL	1991-1996	C/2 O-RING	46002HD
8200	DETROIT DIÉSEL SERIES 50 DIÉSEL	1997-1997	C/2 O-RING	44066HD
8200	DETROIT DIÉSEL SERIES 50 DIÉSEL	1997-1997	C/2 O-RING	46002HD
8200	DETROIT DIÉSEL SERIES 60 DIÉSEL	1997-1997	C/2 O-RING	44066HD
8200	DETROIT DIÉSEL SERIES 60 DIÉSEL	1997-1997	C/2 O-RING	46002HD
8300	CATERPILLAR 3406 DIÉSEL	1993-1994	C/5 O-RING; C/4 JUNTAS	44054HD
8300	CUMMINS 6 CIL. 14.0 L DIÉSEL	1988-1989	C/O-RING; C/2 JUNTAS	44092HD
8300	CUMMINS 6 CIL. 14.0 L DIÉSEL	1990-1990	C/O-RING; C/2 JUNTAS	44052HD
8300	CUMMINS L10 DIÉSEL	1991-1994	C/3 O-RING; C/2 JUNTAS	43307HD
8300	CUMMINS N14 DIÉSEL	1991-1994	C/O-RING; C/2 JUNTAS	44052HD
8300	DETROIT DIÉSEL 6 CIL. 11.1 L DIÉSEL	1991-1994	C/2 O-RING	44066HD
8300	DETROIT DIÉSEL 6 CIL. 11.1 L DIÉSEL	1991-1994	C/2 O-RING	46002HD
8300	DETROIT DIÉSEL 6 CIL. 12.7 L DIÉSEL	1991-1994	C/2 O-RING	44066HD
8300	DETROIT DIÉSEL 6 CIL. 12.7 L DIÉSEL	1991-1994	C/2 O-RING	46002HD
8500	NAVISTAR 530 DIÉSEL	2002-2005	C/O-RING	42318HD

INTERNATIONAL/NAVISTAR (CONTINUACIÓN)

MODELO	MOTOR	AÑOS	DESCRIPCIÓN	NO. PARTE
8500	NAVISTAR DT466 DIÉSEL	2002-2002	C/O-RING	42318HD
8600	CATERPILLAR C12 DIÉSEL	2002-2004	C/8 O-RING; C/3 JUNTAS	44060HD
8600	CUMMINS ISM DIÉSEL	2004-2004	C/6 O-RING; C/JUNTA	45055HD
8600	CATERPILLAR C13 DIÉSEL	2004-2007	C/O-RING	43564HD
9100	CATERPILLAR 3406 DIÉSEL	1998-1998	C/5 O-RING; C/4 JUNTAS	44054HD
9100	CUMMINS M11 DIÉSEL	1998-1998	C/3 O-RING; C/2 JUNTAS	43307HD
9100	CUMMINS N14 DIÉSEL	1998-1999	C/O-RING; C/2 JUNTAS	44052HD
9100	DETROIT DIÉSEL SERIES 60 DIÉSEL	1998-1999	C/2 O-RING	44066HD
9100	DETROIT DIÉSEL SERIES 60 DIÉSEL	1998-1999	C/2 O-RING	46002HD
9100I	CATERPILLAR C12 DIÉSEL	2000-2003	C/8 O-RING; C/3 JUNTAS	44060HD
9100I	CUMMINS ISM DIÉSEL	2000-2000	C/3 O-RING; C/2 JUNTAS	43307HD
9100I	CUMMINS N14 DIÉSEL	2000-2003	C/O-RING; C/2 JUNTAS	44052HD
9100I	DETROIT DIÉSEL 6 CIL. 12.7 L DIÉSEL	2001-2003	C/2 O-RING	44066HD
9100I	DETROIT DIÉSEL 6 CIL. 12.7 L DIÉSEL	2001-2003	C/2 O-RING	46002HD
9100I	DETROIT DIÉSEL SERIES 60 DIÉSEL	2000-2000	C/2 O-RING	44066HD
9100I	DETROIT DIÉSEL SERIES 60 DIÉSEL	2000-2000	C/2 O-RING	46002HD
9200	CATERPILLAR 3406 DIÉSEL	1995-1995	C/5 O-RING; C/4 JUNTAS	44054HD
9200	CATERPILLAR 3406 DIÉSEL	1996-1998	C/5 O-RING; C/4 JUNTAS	44054HD
9200	CUMMINS L10 DIÉSEL	1993-1994	C/3 O-RING; C/2 JUNTAS	43307HD
9200	CUMMINS M11 DIÉSEL	1994-1998	C/3 O-RING; C/2 JUNTAS	43307HD
9200	CUMMINS N14 DIÉSEL	1995-1999	C/O-RING; C/2 JUNTAS	44052HD
9200	DETROIT DIÉSEL 6 CIL. 11.1 L DIÉSEL	1994-1997	C/2 O-RING	44066HD
9200	DETROIT DIÉSEL 6 CIL. 11.1 L DIÉSEL	1994-1997	C/2 O-RING	46002HD
9200	DETROIT DIÉSEL 6 CIL. 12.7 L DIÉSEL	1994-1997	C/2 O-RING	44066HD
9200	DETROIT DIÉSEL 6 CIL. 12.7 L DIÉSEL	1994-1997	C/2 O-RING	46002HD
9200	DETROIT DIÉSEL SERIES 60 DIÉSEL	1998-1999	C/2 O-RING	44066HD
9200	DETROIT DIÉSEL SERIES 60 DIÉSEL	1998-1999	C/2 O-RING	46002HD
9200I	CATERPILLAR C12 DIÉSEL	2000-2004	C/8 O-RING; C/3 JUNTAS	44060HD
9200I	CATERPILLAR C15 DIÉSEL	2003-2004	C/6 O-RING; C/JUNTA	44062HD
9200I	CATERPILLAR C16 DIÉSEL	2003-2003	C/3 O-RING; C/JUNTA	44051HD
9200I	CUMMINS ISM DIÉSEL	2008-2010	C/6 O-RING; C/JUNTA	45055HD
9200I	CUMMINS ISX DIÉSEL	2003-2007	C/2 O-RING	45054HD
9200I	CUMMINS ISX DIÉSEL	2008-2011	C/2 O-RING	45052HD
9200I	CUMMINS N14 DIÉSEL	2000-2003	C/O-RING; C/2 JUNTAS	44052HD
9200I	DETROIT DIÉSEL 6 CIL. 12.7 L DIÉSEL	2001-2003	C/2 O-RING	44066HD
9200I	DETROIT DIÉSEL 6 CIL. 12.7 L DIÉSEL	2001-2003	C/2 O-RING	46002HD
9200I	DETROIT DIÉSEL SERIES 60 DIÉSEL	2000-2000	C/2 O-RING	44066HD
9200I	DETROIT DIÉSEL SERIES 60 DIÉSEL	2000-2000	C/2 O-RING	46002HD
9200I	CATERPILLAR C13 DIÉSEL	2004-2007	C/O-RING	43564HD
9300	CATERPILLAR 3406 DIÉSEL	1993-1995	C/5 O-RING; C/4 JUNTAS	44054HD
9300	CATERPILLAR 3406 DIÉSEL	1996-1999	C/5 O-RING; C/4 JUNTAS	44054HD
9300	CUMMINS 6 CIL. 14.0 L DIÉSEL	1988-1989	C/O-RING; C/2 JUNTAS	44092HD
9300	CUMMINS 6 CIL. 14.0 L DIÉSEL	1990-1990	C/O-RING; C/2 JUNTAS	44052HD
9300	CUMMINS L10 DIÉSEL	1991-1994	C/3 O-RING; C/2 JUNTAS	43307HD
9300	CUMMINS M11 DIÉSEL	1993-1994	C/3 O-RING; C/2 JUNTAS	43307HD
9300	CUMMINS N14 DIÉSEL	1991-1999	C/O-RING; C/2 JUNTAS	44052HD
9300	DETROIT DIÉSEL 6 CIL. 11.1 L DIÉSEL	1992-1997	C/2 O-RING	44066HD

INTERNATIONAL/NAVISTAR (CONTINUACIÓN)

MODELO	MOTOR	AÑOS	DESCRIPCIÓN	NO. PARTE
9300	DETROIT DIÉSEL 6 CIL. 11.1 L DIÉSEL	1992-1997	C/2 O-RING	46002HD
9300	DETROIT DIÉSEL 6 CIL. 12.7 L DIÉSEL	1992-1999	C/2 O-RING	44066HD
9300	DETROIT DIÉSEL 6 CIL. 12.7 L DIÉSEL	1992-1999	C/2 O-RING	46002HD
9300	DETROIT DIÉSEL SERIES 60 DIÉSEL	1998-1998	C/2 O-RING	44066HD
9300	DETROIT DIÉSEL SERIES 60 DIÉSEL	1998-1998	C/2 O-RING	46002HD
9400	CATERPILLAR 3406 DIÉSEL	1993-1995	C/5 O-RING; C/4 JUNTAS	44054HD
9400	CATERPILLAR 3406 DIÉSEL	1996-1999	C/5 O-RING; C/4 JUNTAS	44054HD
9400	CUMMINS 6 CIL. 14.0 L DIÉSEL	1990-1990	C/O-RING; C/2 JUNTAS	44052HD
9400	CUMMINS L10 DIÉSEL	1991-1994	C/3 O-RING; C/2 JUNTAS	43307HD
9400	CUMMINS M11 DIÉSEL	1995-1998	C/3 O-RING; C/2 JUNTAS	43307HD
9400	CUMMINS N14 DIÉSEL	1991-1999	C/O-RING; C/2 JUNTAS	44052HD
9400	DETROIT DIÉSEL 6 CIL. 11.1 L DIÉSEL	1995-1996	C/2 O-RING	44066HD
9400	DETROIT DIÉSEL 6 CIL. 11.1 L DIÉSEL	1995-1996	C/2 O-RING	46002HD
9400	DETROIT DIÉSEL 6 CIL. 12.7 L DIÉSEL	1995-1996	C/2 O-RING	44066HD
9400	DETROIT DIÉSEL 6 CIL. 12.7 L DIÉSEL	1995-1996	C/2 O-RING	46002HD
9400	DETROIT DIÉSEL SERIES 60 DIÉSEL	1992-1999	C/2 O-RING	44066HD
9400	DETROIT DIÉSEL SERIES 60 DIÉSEL	1992-1999	C/2 O-RING	46002HD
9400I	CATERPILLAR 3406 DIÉSEL	2000-2000	C/5 O-RING; C/4 JUNTAS	44054HD
9400I	CATERPILLAR C12 DIÉSEL	2000-2003	C/8 O-RING; C/3 JUNTAS	44060HD
9400I	CATERPILLAR C15 DIÉSEL	2000-2007	C/6 O-RING; C/JUNTA	44062HD
9400I	CATERPILLAR C16 DIÉSEL	2000-2003	C/3 O-RING; C/JUNTA	44051HD
9400I	CUMMINS ISX DIÉSEL	2003-2007	C/2 O-RING	45054HD
9400I	CUMMINS N14 DIÉSEL	2000-2003	C/O-RING; C/2 JUNTAS	44052HD
9400I	DETROIT DIÉSEL 6 CIL. 12.7 L DIÉSEL	2001-2003	C/2 O-RING	44066HD
9400I	DETROIT DIÉSEL 6 CIL. 12.7 L DIÉSEL	2001-2003	C/2 O-RING	46002HD
9400I	DETROIT DIÉSEL SERIES 60 DIÉSEL	2000-2000	C/2 O-RING	44066HD
9400I	DETROIT DIÉSEL SERIES 60 DIÉSEL	2000-2000	C/2 O-RING	46002HD
9400I	CATERPILLAR C13 DIÉSEL	2004-2007	C/O-RING	43564HD
9900	CATERPILLAR 3406 DIÉSEL	1999-1999	C/5 O-RING; C/4 JUNTAS	44054HD
9900	CUMMINS N14 DIÉSEL	1999-1999	C/O-RING; C/2 JUNTAS	44052HD
9900	DETROIT DIÉSEL SERIES 60 DIÉSEL	1999-1999	C/2 O-RING	44066HD
9900	DETROIT DIÉSEL SERIES 60 DIÉSEL	1999-1999	C/2 O-RING	46002HD
9900I	CATERPILLAR 3406 DIÉSEL	2000-2000	C/5 O-RING; C/4 JUNTAS	44054HD
9900I	CATERPILLAR C12 DIÉSEL	2000-2004	C/8 O-RING; C/3 JUNTAS	44060HD
9900I	CATERPILLAR C15 DIÉSEL	2000-2007	C/6 O-RING; C/JUNTA	44062HD
9900I	CATERPILLAR C16 DIÉSEL	2000-2003	C/3 O-RING; C/JUNTA	44051HD
9900I	CUMMINS ISX DIÉSEL	2003-2007	C/2 O-RING	45054HD
9900I	CUMMINS ISX DIÉSEL	2008-2008	C/2 O-RING	45052HD
9900I	CUMMINS ISX15 DIÉSEL	2013-2013	C/2 O-RING	45054HD
9900I	CUMMINS ISX15 DIÉSEL	2014-2017	C/2 O-RING	45052HD
9900I	CUMMINS N14 DIÉSEL	2000-2003	C/O-RING; C/2 JUNTAS	44052HD
9900I	DETROIT DIÉSEL 6 CIL. 12.7 L DIÉSEL	2001-2003	C/2 O-RING	44066HD
9900I	DETROIT DIÉSEL 6 CIL. 12.7 L DIÉSEL	2001-2003	C/2 O-RING	46002HD
9900I	DETROIT DIÉSEL SERIES 60 DIÉSEL	2000-2000	C/2 O-RING	44066HD
9900I	DETROIT DIÉSEL SERIES 60 DIÉSEL	2000-2000	C/2 O-RING	46002HD
9900I	CATERPILLAR C13 DIÉSEL	2004-2007	C/O-RING	43564HD
9900IX	CATERPILLAR 3406 DIÉSEL	2000-2000	C/5 O-RING; C/4 JUNTAS	44054HD

INTERNATIONAL/NAVISTAR (CONTINUACIÓN)

MODELO	MOTOR	AÑOS	DESCRIPCIÓN	NO. PARTE
9900IX	CATERPILLAR C12 DIÉSEL	2000-2003	C/8 O-RING; C/3 JUNTAS	44060HD
9900IX	CATERPILLAR C15 DIÉSEL	2000-2007	C/6 O-RING; C/JUNTA	44062HD
9900IX	CATERPILLAR C16 DIÉSEL	2000-2002	C/3 O-RING; C/JUNTA	44051HD
9900IX	CUMMINS ISX DIÉSEL	2003-2007	C/2 O-RING	45054HD
9900IX	CUMMINS N14 DIÉSEL	2000-2003	C/O-RING; C/2 JUNTAS	44052HD
9900IX	DETROIT DIÉSEL 6 CIL. 12.7 L DIÉSEL	2001-2002	C/2 O-RING	44066HD
9900IX	DETROIT DIÉSEL 6 CIL. 12.7 L DIÉSEL	2001-2002	C/2 O-RING	46002HD
9900IX	DETROIT DIÉSEL SERIES 60 DIÉSEL	2000-2000	C/2 O-RING	44066HD
9900IX	DETROIT DIÉSEL SERIES 60 DIÉSEL	2000-2000	C/2 O-RING	46002HD
CARGOSTAR SERIES	NAVISTAR V8, 9.0 L DIÉSEL	1980-1986	C/O-RING	42114HD
DURASTAR 4300	NAVISTAR MAXXFORCE DT DIÉSEL	2008-2012	C/O-RING	43325HD
F1954	NAVISTAR V8, 9.0 L DIÉSEL	1980-1982	C/O-RING	42114HD
HX SERIES	CUMMINS ISX15 DIÉSEL	2016-2017	C/2 O-RING	45052HD
LONESTAR	CUMMINS ISX DIÉSEL	2009-2011	C/2 O-RING	45052HD
LONESTAR	CUMMINS ISX15 DIÉSEL	2014-2017	C/2 O-RING	45052HD
PAYSTAR 5500I	CUMMINS ISM DIÉSEL	2008-2012	C/6 O-RING; C/JUNTA	45055HD
PAYSTAR 5500I	CUMMINS ISX DIÉSEL	2008-2011	C/2 O-RING	45052HD
PAYSTAR 5600I	CATERPILLAR C15 DIÉSEL	2008-2008	C/6 O-RING; C/JUNTA	44062HD
PAYSTAR 5600I	CATERPILLAR C15 DIÉSEL	2009-2009	C/3 O-RING; C/JUNTA	44051HD
PAYSTAR 5600I	CUMMINS ISL DIÉSEL	2008-2008	C/O-RING	42146HD
PAYSTAR 5600I	CUMMINS ISM DIÉSEL	2009-2009	C/6 O-RING; C/JUNTA	45055HD
PAYSTAR 5600I	CUMMINS ISX DIÉSEL	2008-2011	C/2 O-RING	45052HD
PAYSTAR 5900I	CUMMINS ISX DIÉSEL	2008-2011	C/2 O-RING	45052HD
PAYSTAR 5900I	CUMMINS ISX15 DIÉSEL	2014-2016	C/2 O-RING	45052HD
PROSTAR SERIES	CATERPILLAR C15 DIÉSEL	2008-2009	C/6 O-RING; C/JUNTA	44062HD
PROSTAR SERIES	CUMMINS ISM DIÉSEL	2009-2010	C/6 O-RING; C/JUNTA	45055HD
PROSTAR SERIES	CUMMINS ISX DIÉSEL	2008-2011	C/2 O-RING	45052HD
PROSTAR SERIES	CUMMINS ISX15 DIÉSEL	2013-2016	C/2 O-RING	45052HD
TRANSTAR 8600	CUMMINS ISM DIÉSEL	2008-2008	C/6 O-RING; C/JUNTA	45055HD
WORKSTAR 7600	CUMMINS ISM DIÉSEL	2008-2008	C/6 O-RING; C/JUNTA	45055HD
WORKSTAR 7700	CUMMINS ISM DIÉSEL	2008-2009	C/6 O-RING; C/JUNTA	45055HD

JOHN DEERE

MODELO	MOTOR	AÑOS	DESCRIPCIÓN	NO. PARTE
6950	CUMMINS N14 DIÉSEL	2004-2004	C/O-RING; C/2 JUNTAS	44052HD

KENWORTH

MODELO	MOTOR	AÑOS	DESCRIPCIÓN	NO. PARTE
13-210	CUMMINS C SERIES 8.3 L DIÉSEL	1988-1989	C/O-RING	42352HD
22-210	CUMMINS C SERIES 8.3 L DIÉSEL	1989-1989	C/O-RING	42352HD
C500	CUMMINS 6 CIL. 14.0 L DIÉSEL	1980-1981		41111HD
C500	CUMMINS ISM DIÉSEL	2012-2012	C/6 O-RING; C/JUNTA	45055HD
C500	CUMMINS ISX DIÉSEL	2004-2007	C/2 O-RING	45054HD
C500	CUMMINS ISX15 DIÉSEL	2010-2015	C/2 O-RING	45052HD
C500	CUMMINS ISX15 DIÉSEL	2016-2016	C/2 O-RING	45054HD
C500	DETROIT DIÉSEL 6 CIL. 11.1 L DIÉSEL	1991-1994	C/2 O-RING	44066HD
C500	DETROIT DIÉSEL 6 CIL. 11.1 L DIÉSEL	1991-1994	C/2 O-RING	46002HD

KENWORTH (CONTINUACIÓN)

MODELO	MOTOR	AÑOS	DESCRIPCIÓN	NO. PARTE
C500	DETROIT DIÉSEL 6 CIL. 12.7 L DIÉSEL	1991-1994	C/2 O-RING	44066HD
C500	DETROIT DIÉSEL 6 CIL. 12.7 L DIÉSEL	1991-1994	C/2 O-RING	46002HD
K100	CUMMINS C SERIES 8.3 L DIÉSEL	1992-1993	C/O-RING	42352HD
K130	CUMMINS C SERIES 8.3 L DIÉSEL	1987-1993	C/O-RING	42352HD
K150	CUMMINS C SERIES 8.3 L DIÉSEL	1990-1993	C/O-RING	42352HD
K220	CUMMINS C SERIES 8.3 L DIÉSEL	1988-1993	C/O-RING	42352HD
K300	CUMMINS C SERIES 8.3 L DIÉSEL	1993-1996	C/O-RING	42352HD
K370	PACCAR PX-6 DIÉSEL	2012-2012	C/JUNTA	41199HD
T170	PACCAR PX-6 DIÉSEL	2008-2012	C/JUNTA	41199HD
T2000	CATERPILLAR 3406 DIÉSEL	1997-2000	C/5 O-RING; C/4 JUNTAS	44054HD
T2000	CATERPILLAR C15 DIÉSEL	2000-2007	C/6 O-RING; C/JUNTA	44062HD
T2000	CUMMINS ISX DIÉSEL	2004-2007	C/2 O-RING	45054HD
T2000	CUMMINS ISX DIÉSEL	2009-2009	C/2 O-RING	45052HD
T2000	CUMMINS N14 DIÉSEL	1997-2001	C/O-RING; C/2 JUNTAS	44052HD
T2000	DETROIT DIÉSEL 6 CIL. 11.1 L DIÉSEL	1997-2000	C/2 O-RING	44066HD
T2000	DETROIT DIÉSEL 6 CIL. 11.1 L DIÉSEL	1997-2000	C/2 O-RING	46002HD
T2000	DETROIT DIÉSEL 6 CIL. 12.7 L DIÉSEL	1997-2003	C/2 O-RING	44066HD
T2000	DETROIT DIÉSEL 6 CIL. 12.7 L DIÉSEL	1997-2003	C/2 O-RING	46002HD
T2000	DETROIT DIÉSEL 6 CIL. 12.7 L DIÉSEL	2001-2001	C/2 O-RING	46002HD
T270	PACCAR PX-6 DIÉSEL	2009-2012	C/JUNTA	41199HD
T300	CATERPILLAR C7 DIÉSEL	2004-2007	C/O-RING	43561HD
T300	CUMMINS C SERIES 8.3 L DIÉSEL	1995-1997	C/O-RING	42352HD
T300	CUMMINS ISC DIÉSEL	1998-2008	C/O-RING	42146HD
T370	CUMMINS ISC DIÉSEL	2009-2009	C/O-RING	42146HD
T370	PACCAR PX-6 DIÉSEL	2010-2012	C/JUNTA	41199HD
T370	PACCAR PX-8 DIÉSEL	2008-2012	C/O-RING	42146HD
T400	CUMMINS L10 DIÉSEL	1991-1997	POLEA LOCA DE BA 43307HD	41175HD
T400	CUMMINS L10 DIÉSEL	1991-1997	C/3 O-RING; C/2 JUNTAS	43307HD
T400	CUMMINS M11 DIÉSEL	1995-1997	C/3 O-RING; C/2 JUNTAS	43307HD
T440	PACCAR PX-8 DIÉSEL	2010-2012	C/O-RING	42146HD
T450	CATERPILLAR 3176 DIÉSEL	1994-1996	C/8 O-RING; C/3 JUNTAS	44060HD
T450	CUMMINS L10 DIÉSEL	1991-1995	POLEA LOCA DE BA 43307HD	41175HD
T450	CUMMINS L10 DIÉSEL	1991-1995	C/3 O-RING; C/2 JUNTAS	43307HD
T450	CUMMINS M11 DIÉSEL	1995-1995	C/3 O-RING; C/2 JUNTAS	43307HD
T600	CATERPILLAR 3406 DIÉSEL	1993-1995	C/5 O-RING; C/4 JUNTAS	44054HD
T600	CATERPILLAR 3406 DIÉSEL	1996-1999	C/5 O-RING; C/4 JUNTAS	44054HD
T600	CATERPILLAR C12 DIÉSEL	2000-2004	C/8 O-RING; C/3 JUNTAS	44060HD
T600	CATERPILLAR C15 DIÉSEL	2000-2008	C/6 O-RING; C/JUNTA	44062HD
T600	CUMMINS 6 CIL. 14.0 L DIÉSEL	1986-1989	C/O-RING; C/2 JUNTAS	44092HD
T600	CUMMINS 6 CIL. 14.0 L DIÉSEL	1990-1991	C/O-RING; C/2 JUNTAS	44052HD
T600	CUMMINS ISM DIÉSEL	2000-2004	C/6 O-RING; C/JUNTA	45055HD
T600	CUMMINS ISX DIÉSEL	2002-2003	C/2 O-RING	45051HD
T600	CUMMINS ISX DIÉSEL	2004-2007	C/2 O-RING	45054HD
T600	CUMMINS L10 DIÉSEL	1991-1995	C/3 O-RING; C/2 JUNTAS	43307HD
T600	CUMMINS L10 DIÉSEL	1991-1997	POLEA LOCA DE BA 43307HD	41175HD
T600	CUMMINS M11 DIÉSEL	1995-1997	C/3 O-RING; C/2 JUNTAS	43307HD
T600	CUMMINS N14 DIÉSEL	1990-2001	C/O-RING; C/2 JUNTAS	44052HD

KENWORTH (CONTINUACIÓN)

MODELO	MOTOR	AÑOS	DESCRIPCIÓN	NO. PARTE
T600	DETROIT DIÉSEL 6 CIL. 11.1 L DIÉSEL	1991-1999	C/2 O-RING	44066HD
T600	DETROIT DIÉSEL 6 CIL. 11.1 L DIÉSEL	1991-1999	C/2 O-RING	46002HD
T600	DETROIT DIÉSEL 6 CIL. 12.7 L DIÉSEL	1991-2003	C/2 O-RING	44066HD
T600	DETROIT DIÉSEL 6 CIL. 12.7 L DIÉSEL	1991-2003	C/2 O-RING	46002HD
T660	CATERPILLAR C15 DIÉSEL	2007-2011	C/6 O-RING; C/JUNTA	44062HD
T660	CUMMINS ISM DIÉSEL	2008-2012	C/6 O-RING; C/JUNTA	45055HD
T660	CUMMINS ISX DIÉSEL	2007-2007	C/2 O-RING	45054HD
T660	CUMMINS ISX DIÉSEL	2008-2009	C/2 O-RING	45052HD
T660	CUMMINS ISX15 DIÉSEL	2010-2015	C/2 O-RING	45052HD
T680	CUMMINS ISX15 DIÉSEL	2013-2017	C/2 O-RING	45052HD
T700	CUMMINS ISX15 DIÉSEL	2011-2015	C/2 O-RING	45052HD
T800	CATERPILLAR 3406 DIÉSEL	1993-1995	C/5 O-RING; C/4 JUNTAS	44054HD
T800	CATERPILLAR 3406 DIÉSEL	1996-2000	C/5 O-RING; C/4 JUNTAS	44054HD
T800	CATERPILLAR C10 DIÉSEL	2000-2000	C/8 O-RING; C/3 JUNTAS	44060HD
T800	CATERPILLAR C12 DIÉSEL	2000-2004	C/8 O-RING; C/3 JUNTAS	44060HD
T800	CATERPILLAR C15 DIÉSEL	2000-2009	C/6 O-RING; C/JUNTA	44062HD
T800	CATERPILLAR C15 DIÉSEL	2006-2006	C/6 O-RING; C/JUNTA	44062HD
T800	CATERPILLAR C16 DIÉSEL	2000-2003	C/3 O-RING; C/JUNTA	44051HD
T800	CUMMINS 6 CIL. 14.0 L DIÉSEL	1987-1989	C/O-RING; C/2 JUNTAS	44092HD
T800	CUMMINS 6 CIL. 14.0 L DIÉSEL	1990-1991	C/O-RING; C/2 JUNTAS	44052HD
T800	CUMMINS ISL DIÉSEL	2001-2009	C/O-RING	42146HD
T800	CUMMINS ISM DIÉSEL	2000-2014	C/6 O-RING; C/JUNTA	45055HD
T800	CUMMINS ISX DIÉSEL	2001-2001	C/2 O-RING	45051HD
T800	CUMMINS ISX DIÉSEL	2004-2007	C/2 O-RING	45054HD
T800	CUMMINS ISX DIÉSEL	2009-2009	C/2 O-RING	45052HD
T800	CUMMINS ISX15 DIÉSEL	2010-2016	C/2 O-RING	45052HD
T800	CUMMINS L10 DIÉSEL	1991-1997	POLEA LOCA DE BA 43307HD	41175HD
T800	CUMMINS L10 DIÉSEL	1991-1997	C/3 O-RING; C/2 JUNTAS	43307HD
T800	CUMMINS M11 DIÉSEL	1995-1997	C/3 O-RING; C/2 JUNTAS	43307HD
T800	CUMMINS N14 DIÉSEL	1987-2003	C/O-RING; C/2 JUNTAS	44052HD
T800	DETROIT DIÉSEL 6 CIL. 11.1 L DIÉSEL	1991-2001	C/2 O-RING	44066HD
T800	DETROIT DIÉSEL 6 CIL. 11.1 L DIÉSEL	1991-2001	C/2 O-RING	46002HD
T800	DETROIT DIÉSEL 6 CIL. 12.7 L DIÉSEL	1991-2003	C/2 O-RING	44066HD
T800	DETROIT DIÉSEL 6 CIL. 12.7 L DIÉSEL	1991-2003	C/2 O-RING	46002HD
T800	CATERPILLAR C13 DIÉSEL	2004-2007	C/O-RING	43564HD
T880	CUMMINS ISX15 DIÉSEL	2014-2017	C/2 O-RING	45052HD
W900	CATERPILLAR 3406 DIÉSEL	1993-1995	C/5 O-RING; C/4 JUNTAS	44054HD
W900	CATERPILLAR 3406 DIÉSEL	1996-2000	C/5 O-RING; C/4 JUNTAS	44054HD
W900	CATERPILLAR C12 DIÉSEL	2000-2004	C/8 O-RING; C/3 JUNTAS	44060HD
W900	CATERPILLAR C15 DIÉSEL	2000-2010	C/6 O-RING; C/JUNTA	44062HD
W900	CATERPILLAR C16 DIÉSEL	2000-2003	C/3 O-RING; C/JUNTA	44051HD
W900	CUMMINS 6 CIL. 14.0 L DIÉSEL	1980-1885		41111HD
W900	CUMMINS 6 CIL. 14.0 L DIÉSEL	1985-1985	C/O-RING; C/2 JUNTAS	44092HD
W900	CUMMINS 6 CIL. 14.0 L DIÉSEL	1986-1989	C/O-RING; C/2 JUNTAS	44092HD
W900	CUMMINS 6 CIL. 14.0 L DIÉSEL	1990-1991	C/O-RING; C/2 JUNTAS	44052HD
W900	CUMMINS ISC DIÉSEL	2003-2004	C/O-RING	42146HD
W900	CUMMINS ISM DIÉSEL	1999-2003	C/6 O-RING; C/JUNTA	45055HD

KENWORTH (CONTINUACIÓN)

MODELO	MOTOR	AÑOS	DESCRIPCIÓN	NO. PARTE
W900	CUMMINS ISX DIÉSEL	2000-2000	C/2 O-RING	45051HD
W900	CUMMINS ISX DIÉSEL	2004-2007	C/2 O-RING	45054HD
W900	CUMMINS ISX DIÉSEL	2009-2009	C/2 O-RING	45052HD
W900	CUMMINS ISX15 DIÉSEL	2010-2017	C/2 O-RING	45052HD
W900	CUMMINS M11 DIÉSEL	1996-1997	C/3 O-RING; C/2 JUNTAS	43307HD
W900	CUMMINS N14 DIÉSEL	1992-2003	C/O-RING; C/2 JUNTAS	44052HD
W900	DETROIT DIÉSEL 6 CIL. 11.1 L DIÉSEL	1991-2006	C/2 O-RING	44066HD
W900	DETROIT DIÉSEL 6 CIL. 11.1 L DIÉSEL	1991-2006	C/2 O-RING	46002HD
W900	DETROIT DIÉSEL 6 CIL. 12.7 L DIÉSEL	1991-2006	C/2 O-RING	44066HD
W900	DETROIT DIÉSEL 6 CIL. 12.7 L DIÉSEL	1991-2006	C/2 O-RING	46002HD
W900	CATERPILLAR C13 DIÉSEL	2004-2007	C/O-RING	43564HD

MACK

MODELO	MOTOR	AÑOS	DESCRIPCIÓN	NO. PARTE
CH SERIES	DETROIT DIÉSEL 6 CIL. 12.7 L DIÉSEL	1993-1993	C/2 O-RING	44066HD
CH SERIES	DETROIT DIÉSEL 6 CIL. 12.7 L DIÉSEL	1993-1993	C/2 O-RING	46002HD
CH SERIES	MACK 6 CIL. 12.0 L DIÉSEL	1889-1999	C/2 JUNTAS	43240HD
CH SERIES	MACK 6 CIL. 12.0 L DIÉSEL	2000-2002	C/2 JUNTAS	43236HD
CH SERIES	MACK E7 DIÉSEL	2003-2003	C/2 JUNTAS	43236HD
CH SERIES	MACK EM7 DIÉSEL	2003-2003	C/2 JUNTAS	43236HD
CL SERIES	CATERPILLAR 3406 DIÉSEL	1995-1996	C/5 O-RING; C/4 JUNTAS	44054HD
CL SERIES	CATERPILLAR 3406 DIÉSEL	1998-1999	C/5 O-RING; C/4 JUNTAS	44054HD
CL SERIES	CUMMINS ISX DIÉSEL	2005-2005	C/2 O-RING	45054HD
CL SERIES	DETROIT DIÉSEL 6 CIL. 12.7 L DIÉSEL	1992-2002	C/2 O-RING	44066HD
CL SERIES	DETROIT DIÉSEL 6 CIL. 12.7 L DIÉSEL	1992-2002	C/2 O-RING	46002HD
CM SERIES	CUMMINS C SERIES 8.3 L DIÉSEL	1991-1992	C/O-RING	42352HD

MARCO POLO

MODELO	MOTOR	AÑOS	DESCRIPCIÓN	NO. PARTE
VIAGGIO 1000	DETROIT DIÉSEL SERIES 60 DIÉSEL	1996-1996	C/2 O-RING	44066HD
VIAGGIO 1000	DETROIT DIÉSEL SERIES 60 DIÉSEL	1996-1996	C/2 O-RING	46002HD

NEW HOLLAND

MODELO	MOTOR	AÑOS	DESCRIPCIÓN	NO. PARTE
L190	NEW HOLLAND 445M2 DIÉSEL	2008-2011	C/O-RING	42291

PETERBILT

MODELO	MOTOR	AÑOS	DESCRIPCIÓN	NO. PARTE
200	CUMMINS C SERIES 8.3 L DIÉSEL	1993-1997	C/O-RING	42352HD
224	CUMMINS C SERIES 8.3 L DIÉSEL	1987-1992	C/O-RING	42352HD
227	CUMMINS C SERIES 8.3 L DIÉSEL	1990-1992	C/O-RING	42352HD
265	CUMMINS C SERIES 8.3 L DIÉSEL	1988-1992	C/O-RING	42352HD
320	CUMMINS C SERIES 8.3 L DIÉSEL	1988-1996	C/O-RING	42352HD
330	CUMMINS C SERIES 8.3 L DIÉSEL	1995-1996	C/O-RING	42352HD
357	CUMMINS C SERIES 8.3 L DIÉSEL	1988-1996	C/O-RING	42352HD
375	CUMMINS C SERIES 8.3 L DIÉSEL	1988-1996	C/O-RING	42352HD

PETERBILT (CONTINUACIÓN)

MODELO	MOTOR	AÑOS	DESCRIPCIÓN	NO. PARTE
376	CUMMINS C SERIES 8.3 L DIÉSEL	1988-1993	C/O-RING	42352HD
385	CUMMINS C SERIES 8.3 L DIÉSEL	1996-1996	C/O-RING	42352HD
13-210	CUMMINS C SERIES 8.3 L DIÉSEL	1988-1989	C/O-RING	42352HD
22-210	CUMMINS C SERIES 8.3 L DIÉSEL	1989-1989	C/O-RING	42352HD
325	PACCAR PX-6 DIÉSEL	2008-2012	C/JUNTA	41199HD
330	CATERPILLAR 3406 DIÉSEL	1999-2000	C/5 O-RING; C/4 JUNTAS	44054HD
330	CUMMINS ISC DIÉSEL	1997-2007	C/O-RING	42146HD
330	PACCAR PX-6 DIÉSEL	2008-2011	C/JUNTA	41199HD
335	CUMMINS ISC DIÉSEL	2005-2007	C/O-RING	42146HD
335	PACCAR PX-6 DIÉSEL	2008-2010	C/JUNTA	41199HD
337	PACCAR PX-6 DIÉSEL	2010-2013	C/JUNTA	41199HD
357	CATERPILLAR 3406 DIÉSEL	1993-1995	C/5 O-RING; C/4 JUNTAS	44054HD
357	CATERPILLAR 3406 DIÉSEL	1996-1999	C/5 O-RING; C/4 JUNTAS	44054HD
357	CATERPILLAR C12 DIÉSEL	2000-2004	C/8 O-RING; C/3 JUNTAS	44060HD
357	CATERPILLAR C15 DIÉSEL	2000-2007	C/6 O-RING; C/JUNTA	44062HD
357	CATERPILLAR C16 DIÉSEL	2002-2002	C/3 O-RING; C/JUNTA	44051HD
357	CUMMINS 6 CIL. 14.0 L DIÉSEL	1987-1989	C/O-RING; C/2 JUNTAS	44092HD
357	CUMMINS 6 CIL. 14.0 L DIÉSEL	1990-1991	C/O-RING; C/2 JUNTAS	44052HD
357	CUMMINS ISM DIÉSEL	2000-2001	C/6 O-RING; C/JUNTA	45055HD
357	CUMMINS ISX DIÉSEL	2006-2006	C/2 O-RING	45051HD
357	CUMMINS ISX DIÉSEL	2007-2007	C/2 O-RING	45052HD
357	CUMMINS L10 DIÉSEL	1991-1997	C/3 O-RING; C/2 JUNTAS	43307HD
357	CUMMINS M11 DIÉSEL	1994-1997	C/3 O-RING; C/2 JUNTAS	43307HD
357	CUMMINS N14 DIÉSEL	1992-1997	C/O-RING; C/2 JUNTAS	44052HD
357	DETROIT DIÉSEL 6 CIL. 11.1 L DIÉSEL	1992-1999	C/2 O-RING	44066HD
357	DETROIT DIÉSEL 6 CIL. 11.1 L DIÉSEL	1992-1999	C/2 O-RING	46002HD
357	DETROIT DIÉSEL 6 CIL. 12.7 L DIÉSEL	1989-2003	C/2 O-RING	44066HD
357	DETROIT DIÉSEL 6 CIL. 12.7 L DIÉSEL	1989-2003	C/2 O-RING	46002HD
357	CATERPILLAR C13 DIÉSEL	2005-2007	C/O-RING	43564HD
365	CUMMINS ISL DIÉSEL	2008-2008	C/O-RING	42146HD
365	CUMMINS ISM DIÉSEL	2008-2008	C/6 O-RING; C/JUNTA	45055HD
367	CATERPILLAR C15 DIÉSEL	2008-2011	C/6 O-RING; C/JUNTA	44062HD
367	CUMMINS ISM DIÉSEL	2008-2011	C/6 O-RING; C/JUNTA	45055HD
367	CUMMINS ISX DIÉSEL	2007-2009	C/2 O-RING	45052HD
367	CUMMINS ISX15 DIÉSEL	2010-2016	C/2 O-RING	45052HD
375	CUMMINS L10 DIÉSEL	1991-1996	C/3 O-RING; C/2 JUNTAS	43307HD
377	CATERPILLAR 3406 DIÉSEL	1993-1995	C/5 O-RING; C/4 JUNTAS	44054HD
377	CATERPILLAR 3406 DIÉSEL	1996-1999	C/5 O-RING; C/4 JUNTAS	44054HD
377	CATERPILLAR C15 DIÉSEL	2000-2000	C/3 O-RING; C/JUNTA	44051HD
377	CUMMINS 6 CIL. 14.0 L DIÉSEL	1987-1989	C/O-RING; C/2 JUNTAS	44092HD
377	CUMMINS 6 CIL. 14.0 L DIÉSEL	1990-1991	C/O-RING; C/2 JUNTAS	44052HD
377	CUMMINS L10 DIÉSEL	1992-1997	C/3 O-RING; C/2 JUNTAS	43307HD
377	CUMMINS M11 DIÉSEL	1997-1997	C/3 O-RING; C/2 JUNTAS	43307HD
377	CUMMINS N14 DIÉSEL	1992-1999	C/O-RING; C/2 JUNTAS	44052HD
377	DETROIT DIÉSEL 6 CIL. 11.1 L DIÉSEL	1992-2000	C/2 O-RING	44066HD
377	DETROIT DIÉSEL 6 CIL. 11.1 L DIÉSEL	1992-2000	C/2 O-RING	46002HD
377	DETROIT DIÉSEL 6 CIL. 12.7 L DIÉSEL	1988-2001	C/2 O-RING	44066HD

PETERBILT (CONTINUACIÓN)

MODELO	MOTOR	AÑOS	DESCRIPCIÓN	NO. PARTE
377	DETROIT DIÉSEL 6 CIL. 12.7 L DIÉSEL	1988-2001	C/2 O-RING	46002HD
378	CATERPILLAR 3406 DIÉSEL	1993-1995	C/5 O-RING; C/4 JUNTAS	44054HD
378	CATERPILLAR 3406 DIÉSEL	1996-1999	C/5 O-RING; C/4 JUNTAS	44054HD
378	CATERPILLAR C12 DIÉSEL	1997-2004	C/8 O-RING; C/3 JUNTAS	44060HD
378	CATERPILLAR C15 DIÉSEL	2000-2007	C/6 O-RING; C/JUNTA	44062HD
378	CATERPILLAR C16 DIÉSEL	2000-2001	C/3 O-RING; C/JUNTA	44051HD
378	CUMMINS 6 CIL. 14.0 L DIÉSEL	1988-1989	C/O-RING; C/2 JUNTAS	44092HD
378	CUMMINS 6 CIL. 14.0 L DIÉSEL	1990-1991	C/O-RING; C/2 JUNTAS	44052HD
378	CUMMINS ISX DIÉSEL	2006-2006	C/2 O-RING	45051HD
378	CUMMINS ISX DIÉSEL	2007-2007	C/2 O-RING	45052HD
378	CUMMINS L10 DIÉSEL	1988-1997	C/3 O-RING; C/2 JUNTAS	43307HD
378	CUMMINS M11 DIÉSEL	1995-1997	C/3 O-RING; C/2 JUNTAS	43307HD
378	CUMMINS N14 DIÉSEL	1992-2003	C/O-RING; C/2 JUNTAS	44052HD
378	DETROIT DIÉSEL 6 CIL. 11.1 L DIÉSEL	1992-1999	C/2 O-RING	44066HD
378	DETROIT DIÉSEL 6 CIL. 11.1 L DIÉSEL	1992-1999	C/2 O-RING	46002HD
378	DETROIT DIÉSEL 6 CIL. 12.7 L DIÉSEL	1988-2004	C/2 O-RING	44066HD
378	DETROIT DIÉSEL 6 CIL. 12.7 L DIÉSEL	1988-2004	C/2 O-RING	46002HD
378	CATERPILLAR C13 DIÉSEL	2005-2006	C/O-RING	43564HD
379	CATERPILLAR 3406 DIÉSEL	1993-1995	C/5 O-RING; C/4 JUNTAS	44054HD
379	CATERPILLAR 3406 DIÉSEL	1996-2000	C/5 O-RING; C/4 JUNTAS	44054HD
379	CATERPILLAR C12 DIÉSEL	1997-2004	C/8 O-RING; C/3 JUNTAS	44060HD
379	CATERPILLAR C15 DIÉSEL	2000-2007	C/6 O-RING; C/JUNTA	44062HD
379	CATERPILLAR C16 DIÉSEL	2000-2003	C/3 O-RING; C/JUNTA	44051HD
379	CUMMINS 6 CIL. 14.0 L DIÉSEL	1987-1989	C/O-RING; C/2 JUNTAS	44092HD
379	CUMMINS 6 CIL. 14.0 L DIÉSEL	1990-1991	C/O-RING; C/2 JUNTAS	44052HD
379	CUMMINS ISX DIÉSEL	2006-2006	C/2 O-RING	45051HD
379	CUMMINS ISX DIÉSEL	2007-2007	C/2 O-RING	45054HD
379	CUMMINS N14 DIÉSEL	1992-2003	C/O-RING; C/2 JUNTAS	44052HD
379	DETROIT DIÉSEL 6 CIL. 11.1 L DIÉSEL	1992-2001	C/2 O-RING	44066HD
379	DETROIT DIÉSEL 6 CIL. 11.1 L DIÉSEL	1992-2001	C/2 O-RING	46002HD
379	DETROIT DIÉSEL 6 CIL. 12.7 L DIÉSEL	1988-2003	C/2 O-RING	44066HD
379	DETROIT DIÉSEL 6 CIL. 12.7 L DIÉSEL	1988-2003	C/2 O-RING	46002HD
379	CATERPILLAR C13 DIÉSEL	2004-2007	C/O-RING	43564HD
384	CUMMINS ISM DIÉSEL	2010-2010	C/6 O-RING; C/JUNTA	45055HD
385	CATERPILLAR C12 DIÉSEL	2000-2004	C/8 O-RING; C/3 JUNTAS	44060HD
385	CUMMINS ISM DIÉSEL	2000-2000	C/6 O-RING; C/JUNTA	45055HD
385	CUMMINS ISX DIÉSEL	2007-2007	C/2 O-RING	45052HD
385	CUMMINS N14 DIÉSEL	2002-2003	C/O-RING; C/2 JUNTAS	44052HD
385	DETROIT DIÉSEL 6 CIL. 12.7 L DIÉSEL	2001-2003	C/2 O-RING	44066HD
385	DETROIT DIÉSEL 6 CIL. 12.7 L DIÉSEL	2001-2003	C/2 O-RING	46002HD
385	CATERPILLAR C13 DIÉSEL	2005-2007	C/O-RING	43564HD
386	CATERPILLAR C15 DIÉSEL	2006-2010	C/6 O-RING; C/JUNTA	44062HD
386	CUMMINS ISX DIÉSEL	2007-2007	C/2 O-RING	45054HD
386	CUMMINS ISX DIÉSEL	2008-2009	C/2 O-RING	45052HD
386	CUMMINS ISX15 DIÉSEL	2010-2014	C/2 O-RING	45052HD
386	CATERPILLAR C13 DIÉSEL	2006-2007	C/O-RING	43564HD
387	CATERPILLAR C12 DIÉSEL	2000-2003	C/8 O-RING; C/3 JUNTAS	44060HD

PETERBILT (CONTINUACIÓN)

MODELO	MOTOR	AÑOS	DESCRIPCIÓN	NO. PARTE
387	CATERPILLAR C15 DIÉSEL	2001-2008	C/6 O-RING; C/JUNTA	44062HD
387	CUMMINS ISX DIÉSEL	2006-2006	C/2 O-RING	45051HD
387	CUMMINS ISX DIÉSEL	2008-2009	C/2 O-RING	45052HD
387	CUMMINS ISX15 DIÉSEL	2010-2011	C/2 O-RING	45052HD
387	DETROIT DIÉSEL 6 CIL. 12.7 L DIÉSEL	2001-2001	C/2 O-RING	44066HD
387	DETROIT DIÉSEL 6 CIL. 12.7 L DIÉSEL	2001-2001	C/2 O-RING	46002HD
387	CATERPILLAR C13 DIÉSEL	2004-2007	C/O-RING	43564HD
388	CATERPILLAR C15 DIÉSEL	2007-2011	C/6 O-RING; C/JUNTA	44062HD
388	CUMMINS ISM DIÉSEL	2008-2008	C/6 O-RING; C/JUNTA	45055HD
388	CUMMINS ISX DIÉSEL	2008-2008	C/2 O-RING	45052HD
388	CUMMINS ISX15 DIÉSEL	2010-2015	C/2 O-RING	45052HD
388	CUMMINS ISX15 DIÉSEL	2013-2014	C/2 O-RING	45054HD
388	CUMMINS ISX-G LNG	2011-2011	C/2 O-RING	45052HD
388	CUMMINS ISX-G LNG	2012-2012	C/2 O-RING	45054HD
567	CUMMINS ISX15 DIÉSEL	2015-2015	C/2 O-RING	45054HD
567	CUMMINS ISX15 DIÉSEL	2016-2017	C/2 O-RING	45052HD
579	CUMMINS ISX15 DIÉSEL	2014-2014	C/2 O-RING	45054HD
579	CUMMINS ISX15 DIÉSEL	2015-2016	C/2 O-RING	45052HD
587	CUMMINS ISX15 DIÉSEL	2011-2016	C/2 O-RING	45052HD

SCANIA

MODELO	MOTOR	AÑOS	DESCRIPCIÓN	NO. PARTE
G-SERIES	SCANIA 5 CIL. 8.9 L DIÉSEL	2001-2009	C/JUNTA	49012
G-SERIES	SCANIA 5 CIL. 9.3 L DIÉSEL	2005-2009	C/JUNTA	49012
G-SERIES	SCANIA 6 CIL. 11.7 L DIÉSEL	2009-2010	C/JUNTA	49012
G-SERIES	SCANIA 6 CIL. 12.7 L DIÉSEL	2008-2011	C/JUNTA	49012
P-SERIES	SCANIA 5 CIL. 8.9 L DIÉSEL	2001-2009	C/JUNTA	49012
P-SERIES	SCANIA 5 CIL. 9.3 L DIÉSEL	2006-2006	C/JUNTA	49012
P-SERIES	SCANIA 5 CIL. 9.3 L DIÉSEL	2007-2009	C/JUNTA	49012
P-SERIES	SCANIA 6 CIL. 11.0 L DIÉSEL	2006-2006	C/JUNTA	49012
P-SERIES	SCANIA 6 CIL. 11.0 L DIÉSEL	2007-2009	C/JUNTA	49012
P-SERIES	SCANIA 6 CIL. 11.7 L DIÉSEL	2008-2010	C/JUNTA	49012
P-SERIES	SCANIA 6 CIL. 12.7 L DIÉSEL	2008-2011	C/JUNTA	49012
P-SERIES	SCANIA 6 CIL. 15.6 L DIÉSEL	2006-2006	C/JUNTA	49012
P-SERIES	SCANIA 6 CIL. 15.6 L DIÉSEL	2007-2009	C/JUNTA	49012
R-SERIES	SCANIA 6 CIL. 11.0 L DIÉSEL	2006-2006	C/JUNTA	49012
R-SERIES	SCANIA 6 CIL. 11.0 L DIÉSEL	2007-2009	C/JUNTA	49012
R-SERIES	SCANIA 6 CIL. 11.7 L DIÉSEL	2009-2010	C/JUNTA	49012
R-SERIES	SCANIA 6 CIL. 12.7 L DIÉSEL	2008-2011	C/JUNTA	49012
R-SERIES	SCANIA 6 CIL. 15.6 L DIÉSEL	2006-2009	C/JUNTA	49012

STERLING

MODELO	MOTOR	AÑOS	DESCRIPCIÓN	NO. PARTE
A LINE	CATERPILLAR C11 DIÉSEL	2005-2007	C/O-RING	43564HD
A LINE	CATERPILLAR C13 DIÉSEL	2004-2007	C/O-RING	43564HD
ACTERRA	CATERPILLAR C13 DIÉSEL	2004-2006	C/O-RING	43564HD
CONDOR	CATERPILLAR C10 DIÉSEL	2002-2003	C/8 O-RING; C/3 JUNTAS	44060HD

STERLING (CONTINUACIÓN)

MODELO	MOTOR	AÑOS	DESCRIPCIÓN	NO. PARTE
CONDOR	CATERPILLAR C12 DIÉSEL	2002-2003	C/8 O-RING; C/3 JUNTAS	44060HD
CONDOR	CATERPILLAR C11 DIÉSEL	2005-2005	C/O-RING	43564HD
CONDOR	CATERPILLAR C13 DIÉSEL	2004-2006	C/O-RING	43564HD
L LINE	CATERPILLAR C11 DIÉSEL	2004-2007	C/O-RING	43564HD
L LINE	CATERPILLAR C13 DIÉSEL	2004-2007	C/O-RING	43564HD

TEREX

MODELO	MOTOR	AÑOS	DESCRIPCIÓN	NO. PARTE
T500 SERIES	DETROIT DIÉSEL 6 CIL. 12.7 L DIÉSEL	2004-2006	C/2 O-RING	46002HD
T700 SERIES	DETROIT DIÉSEL 6 CIL. 12.7 L DIÉSEL	2003-2006	C/2 O-RING	46002HD
T700 SERIES	DETROIT DIÉSEL 6 CIL. 14.0 L DIÉSEL	2003-2006	C/2 O-RING	46002HD

VOLVO

MODELO	MOTOR	AÑOS	DESCRIPCIÓN	NO. PARTE
AUTOHAULER	DETROIT DIÉSEL 6 CIL. 11.1 L DIÉSEL	1996-2001	C/2 O-RING	44066HD
AUTOHAULER	DETROIT DIÉSEL 6 CIL. 11.1 L DIÉSEL	1996-2001	C/2 O-RING	46002HD
AUTOHAULER	DETROIT DIÉSEL 6 CIL. 12.7 L DIÉSEL	1997-2001	C/2 O-RING	44066HD
AUTOHAULER	DETROIT DIÉSEL 6 CIL. 12.7 L DIÉSEL	1997-2001	C/2 O-RING	46002HD
AUTOHAULER	DETROIT DIÉSEL SERIES 60 DIÉSEL	1991-1993	C/2 O-RING	44066HD
AUTOHAULER	DETROIT DIÉSEL SERIES 60 DIÉSEL	1991-1993	C/2 O-RING	46002HD
VHD	CUMMINS N14 DIÉSEL	2001-2001	C/O-RING; C/2 JUNTAS	44052HD
VHD	DETROIT DIÉSEL SERIES 60 DIÉSEL	2001-2001	C/2 O-RING	44066HD
VHD	DETROIT DIÉSEL SERIES 60 DIÉSEL	2001-2001	C/2 O-RING	46002HD
VN SERIES	CATERPILLAR 3406 DIÉSEL	1997-1999	C/5 O-RING; C/4 JUNTAS	44054HD
VN SERIES	CUMMINS ISM DIÉSEL	2003-2003	C/6 O-RING; C/JUNTA	45055HD
VN SERIES	CUMMINS ISX DIÉSEL	2004-2007	C/2 O-RING	45054HD
VN SERIES	CUMMINS ISX DIÉSEL	2009-2009	C/2 O-RING	45052HD
VN SERIES	CUMMINS ISX15 DIÉSEL	2010-2016	C/2 O-RING	45052HD
VN SERIES	CUMMINS N14 DIÉSEL	1998-2003	C/O-RING; C/2 JUNTAS	44052HD
VN SERIES	DETROIT DIÉSEL 6 CIL. 11.1 L DIÉSEL	1998-2002	C/2 O-RING	44066HD
VN SERIES	DETROIT DIÉSEL 6 CIL. 11.1 L DIÉSEL	1998-2002	C/2 O-RING	46002HD
VN SERIES	DETROIT DIÉSEL 6 CIL. 12.7 L DIÉSEL	1998-2003	C/2 O-RING	44066HD
VN SERIES	DETROIT DIÉSEL 6 CIL. 12.7 L DIÉSEL	1998-2003	C/2 O-RING	46002HD
VT SERIES	CUMMINS ISX DIÉSEL	2009-2009	C/2 O-RING	45052HD



NO. PARTE



#	ARMADORA	MODELO	MOTOR	AÑOS
41111HD	FREIGHTLINER	FLC	CUMMINS 6 CIL. 14.0 L DIÉSEL	1980-1981
41111HD	FREIGHTLINER	FLC	CUMMINS 6 CIL. 14.0 L DIÉSEL	1985-1985
41111HD	FREIGHTLINER	FLT	CUMMINS 6 CIL. 14.0 L DIÉSEL	1980-1981
41111HD	FREIGHTLINER	FLT	CUMMINS 6 CIL. 14.0 L DIÉSEL	1985-1985
41111HD	KENWORTH	C500	CUMMINS 6 CIL. 14.0 L DIÉSEL	1980-1981
41111HD	KENWORTH	W900	CUMMINS 6 CIL. 14.0 L DIÉSEL	1980-1985
41175HD	FORD	L8000	CUMMINS L10 DIÉSEL	1991-1992
41175HD	FORD	L9000	CUMMINS L10 DIÉSEL	1991-1997
41175HD	FREIGHTLINER	FLA	CUMMINS L10 DIÉSEL	1991-1994
41175HD	FREIGHTLINER	FLB	CUMMINS L10 DIÉSEL	1995-1996
41175HD	FREIGHTLINER	FLC	CUMMINS L10 DIÉSEL	1991-1996
41175HD	FREIGHTLINER	FLD	CUMMINS L10 DIÉSEL	1991-1996
41175HD	FREIGHTLINER	FLL	CUMMINS L10 DIÉSEL	1989-1996
41175HD	INTERNATIONAL/ NAVISTAR	5000	CUMMINS L10 DIÉSEL	1991-1998
41175HD	INTERNATIONAL/ NAVISTAR	8100	CUMMINS L10 DIÉSEL	1991-1997
41175HD	INTERNATIONAL/ NAVISTAR	8200	CUMMINS L10 DIÉSEL	1991-1997
41175HD	KENWORTH	T400	CUMMINS L10 DIÉSEL	1991-1997
41175HD	KENWORTH	T450	CUMMINS L10 DIÉSEL	1991-1995
41175HD	KENWORTH	T600	CUMMINS L10 DIÉSEL	1991-1997
41175HD	KENWORTH	T800	CUMMINS L10 DIÉSEL	1991-1997
41181	FREIGHTLINER	FL50	CUMMINS B SERIES 5.9 L DIÉSEL	1995-1997
41181	FREIGHTLINER	FL50	CUMMINS ISB DIÉSEL	1998-1998
41181	FREIGHTLINER	FL60	CUMMINS B SERIES 5.9 L DIÉSEL	1991-1997
41181	FREIGHTLINER	FL60	CUMMINS ISB DIÉSEL	1998-1998
41181	FREIGHTLINER	FL70	CUMMINS B SERIES 5.9 L DIÉSEL	1991-1997
41181	FREIGHTLINER	FL70	CUMMINS ISB DIÉSEL	1998-1998
41181	FREIGHTLINER	FL80	CUMMINS B SERIES 5.9 L DIÉSEL	1991-1997
41181	FREIGHTLINER	FL80	CUMMINS ISB DIÉSEL	1998-1998
41181	FREIGHTLINER	MT35	CUMMINS 4 CIL. 3.9 L DIÉSEL	1997-2001
41181	FREIGHTLINER	MT55	CUMMINS ISB DIÉSEL	2010-2010
41199HD	FREIGHTLINER	MT45	CUMMINS ISB DIÉSEL	2008-2009
41199HD	FREIGHTLINER	MT55	CUMMINS ISB DIÉSEL	2008-2009
41199HD	KENWORTH	K370	PACCAR PX-6 DIÉSEL	2012-2012
41199HD	KENWORTH	T170	PACCAR PX-6 DIÉSEL	2008-2012
41199HD	KENWORTH	T270	PACCAR PX-6 DIÉSEL	2009-2012
41199HD	KENWORTH	T370	PACCAR PX-6 DIÉSEL	2010-2012
41199HD	PETERBILT	325	PACCAR PX-6 DIÉSEL	2008-2012
41199HD	PETERBILT	330	PACCAR PX-6 DIÉSEL	2008-2011
41199HD	PETERBILT	335	PACCAR PX-6 DIÉSEL	2008-2010
41199HD	PETERBILT	337	PACCAR PX-6 DIÉSEL	2010-2013
42114HD	INTERNATIONAL/ NAVISTAR	1654	NAVISTAR V8, 9.0 L DIÉSEL	1980-1982
42114HD	INTERNATIONAL/ NAVISTAR	1754	NAVISTAR V8, 9.0 L DIÉSEL	1980-1988

#	ARMADORA	MODELO	MOTOR	AÑOS
42114HD	INTERNATIONAL/ NAVISTAR	1854	NAVISTAR V8, 9.0 L DIÉSEL	1980-1988
42114HD	INTERNATIONAL/ NAVISTAR	1954	NAVISTAR V8, 9.0 L DIÉSEL	1980-1984
42114HD	INTERNATIONAL/ NAVISTAR	1955	NAVISTAR V8, 9.0 L DIÉSEL	1980-1982
42114HD	INTERNATIONAL/ NAVISTAR	2155	NAVISTAR V8, 9.0 L DIÉSEL	1980-1980
42114HD	INTERNATIONAL/ NAVISTAR	2275	NAVISTAR V8, 9.0 L DIÉSEL	1980-1980
42114HD	INTERNATIONAL/ NAVISTAR	CARGOSTAR SERIES	NAVISTAR V8, 9.0 L DIÉSEL	1980-1986
42114HD	INTERNATIONAL/ NAVISTAR	F1954	NAVISTAR V8, 9.0 L DIÉSEL	1980-1982
42133	DODGE	RAM 4500 HD	CUMMINS DIÉSEL 6.7 L	2013-2018
42133	DODGE	RAM 5500	CUMMINS DIÉSEL 6.7 L	2013-2018
42146HD	FREIGHTLINER	CLASS M2	CUMMINS ISC DIÉSEL	2004-2008
42146HD	FREIGHTLINER	CONDOR	CUMMINS ISC DIÉSEL	2001-2006
42146HD	FREIGHTLINER	CONDOR	CUMMINS ISL DIÉSEL	2001-2007
42146HD	FREIGHTLINER	FL50	CUMMINS ISC DIÉSEL	1998-2005
42146HD	FREIGHTLINER	FL60	CUMMINS ISC DIÉSEL	1998-2004
42146HD	FREIGHTLINER	FL70	CUMMINS ISC DIÉSEL	1998-2005
42146HD	FREIGHTLINER	FL80	CUMMINS ISC DIÉSEL	1998-2005
42146HD	FREIGHTLINER	FLB	CUMMINS ISC DIÉSEL	1998-1998
42146HD	FREIGHTLINER	FLD	CUMMINS ISC DIÉSEL	1998-2002
42146HD	INTERNATIONAL/ NAVISTAR	PAYSTAR 5600I	CUMMINS ISL DIÉSEL	2008-2008
42146HD	KENWORTH	T300	CUMMINS ISC DIÉSEL	1998-2008
42146HD	KENWORTH	T370	CUMMINS ISC DIÉSEL	2009-2009
42146HD	KENWORTH	T370	PACCAR PX-8 DIÉSEL	2008-2012
42146HD	KENWORTH	T440	PACCAR PX-8 DIÉSEL	2010-2012
42146HD	KENWORTH	T800	CUMMINS ISL DIÉSEL	2001-2009
42146HD	KENWORTH	W900	CUMMINS ISC DIÉSEL	2003-2004
42146HD	PETERBILT	330	CUMMINS ISC DIÉSEL	1997-2007
42146HD	PETERBILT	335	CUMMINS ISC DIÉSEL	2005-2007
42146HD	PETERBILT	365	CUMMINS ISL DIÉSEL	2008-2008
42291	AGCO	LT75	CUMMINS 4 CIL. 4.5 L DIÉSEL	2004-2005
42291	AGCO	LT90	CUMMINS 4 CIL. 4.5 L DIÉSEL	2004-2005
42291	DODGE	RAM 4500 HD	CUMMINS 6 CIL. 6.7 L DIÉSEL	2008-2012
42291	DODGE	RAM 5000 HD	CUMMINS 6 CIL. 6.7 L DIÉSEL	2008-2012
42291	FORD	F650 SUPER DUTY	CUMMINS ISB DIÉSEL	2007-2008
42291	FORD	F750 SUPER DUTY	CUMMINS ISB DIÉSEL	2007-2007
42291	FREIGHTLINER	MT35	CUMMINS 4 CIL. 3.9 L DIÉSEL	2002-2003
42291	FREIGHTLINER	MT35	CUMMINS ISB DIÉSEL	2004-2005
42291	FREIGHTLINER	MT45	CUMMINS ISB DIÉSEL	2005-2010
42291	FREIGHTLINER	MT55	CUMMINS ISB DIÉSEL	2004-2004
42291	NEW HOLLAND	L190	NEW HOLLAND 445M2 DIÉSEL	2008-2011

#	ARMADORA	MODELO	MOTOR	AÑOS
42318HD	INTERNATIONAL/NAVISTAR	2554	NAVISTAR 530 DIÉSEL	1995-2002
42318HD	INTERNATIONAL/NAVISTAR	2554	NAVISTAR DT466 DIÉSEL	1996-2002
42318HD	INTERNATIONAL/NAVISTAR	2574	NAVISTAR 530 DIÉSEL	1994-2003
42318HD	INTERNATIONAL/NAVISTAR	2574	NAVISTAR DT466 DIÉSEL	2001-2002
42318HD	INTERNATIONAL/NAVISTAR	2654	NAVISTAR 530 DIÉSEL	1995-2002
42318HD	INTERNATIONAL/NAVISTAR	2654	NAVISTAR DT466 DIÉSEL	1994-2002
42318HD	INTERNATIONAL/NAVISTAR	2674	NAVISTAR 530 DIÉSEL	1994-2003
42318HD	INTERNATIONAL/NAVISTAR	2674	NAVISTAR DT466 DIÉSEL	2001-2003
42318HD	INTERNATIONAL/NAVISTAR	4300	NAVISTAR DT466 DIÉSEL	2002-2002
42318HD	INTERNATIONAL/NAVISTAR	4400	NAVISTAR 530 DIÉSEL	2002-2005
42318HD	INTERNATIONAL/NAVISTAR	4400	NAVISTAR DT466 DIÉSEL	2002-2005
42318HD	INTERNATIONAL/NAVISTAR	4700	NAVISTAR 530 DIÉSEL	1997-2003
42318HD	INTERNATIONAL/NAVISTAR	4700	NAVISTAR DT408 DIÉSEL	1994-1997
42318HD	INTERNATIONAL/NAVISTAR	4700	NAVISTAR DT466 DIÉSEL	1995-2002
42318HD	INTERNATIONAL/NAVISTAR	4800	NAVISTAR 530 DIÉSEL	1996-2002
42318HD	INTERNATIONAL/NAVISTAR	4800	NAVISTAR DT408 DIÉSEL	1994-1997
42318HD	INTERNATIONAL/NAVISTAR	4800	NAVISTAR DT466 DIÉSEL	1995-2003
42318HD	INTERNATIONAL/NAVISTAR	4900	NAVISTAR 530 DIÉSEL	1994-2003
42318HD	INTERNATIONAL/NAVISTAR	4900	NAVISTAR DT408 DIÉSEL	1994-1997
42318HD	INTERNATIONAL/NAVISTAR	4900	NAVISTAR DT466 DIÉSEL	1995-2003
42318HD	INTERNATIONAL/NAVISTAR	5600I	NAVISTAR 530 DIÉSEL	2000-2005
42318HD	INTERNATIONAL/NAVISTAR	7100	NAVISTAR 530 DIÉSEL	1994-1994
42318HD	INTERNATIONAL/NAVISTAR	7300	NAVISTAR DT466 DIÉSEL	2002-2004
42318HD	INTERNATIONAL/NAVISTAR	7400	NAVISTAR 530 DIÉSEL	2002-2003
42318HD	INTERNATIONAL/NAVISTAR	7400	NAVISTAR DT466 DIÉSEL	2002-2003
42318HD	INTERNATIONAL/NAVISTAR	8100	NAVISTAR 530 DIÉSEL	1994-2003
42318HD	INTERNATIONAL/NAVISTAR	8100	NAVISTAR DT466 DIÉSEL	1995-2003
42318HD	INTERNATIONAL/NAVISTAR	8500	NAVISTAR 530 DIÉSEL	2002-2005
42318HD	INTERNATIONAL/NAVISTAR	8500	NAVISTAR DT466 DIÉSEL	2002-2002

#	ARMADORA	MODELO	MOTOR	AÑOS
42352HD	FREIGHTLINER	FL50	CUMMINS C SERIES 8.3 L DIÉSEL	1995-1996
42352HD	FREIGHTLINER	FL60	CUMMINS C SERIES 8.3 L DIÉSEL	1994-1996
42352HD	FREIGHTLINER	FL70	CUMMINS C SERIES 8.3 L DIÉSEL	1994-1996
42352HD	FREIGHTLINER	FL80	CUMMINS C SERIES 8.3 L DIÉSEL	1994-1996
42352HD	FREIGHTLINER	FLC	CUMMINS C SERIES 8.3 L DIÉSEL	1995-1997
42352HD	FREIGHTLINER	FLD	CUMMINS C SERIES 8.3 L DIÉSEL	1995-1996
42352HD	KENWORTH	13-210	CUMMINS C SERIES 8.3 L DIÉSEL	1988-1989
42352HD	KENWORTH	22-210	CUMMINS C SERIES 8.3 L DIÉSEL	1989-1989
42352HD	KENWORTH	K100	CUMMINS C SERIES 8.3 L DIÉSEL	1992-1993
42352HD	KENWORTH	K130	CUMMINS C SERIES 8.3 L DIÉSEL	1987-1993
42352HD	KENWORTH	K150	CUMMINS C SERIES 8.3 L DIÉSEL	1990-1993
42352HD	KENWORTH	K220	CUMMINS C SERIES 8.3 L DIÉSEL	1988-1993
42352HD	KENWORTH	K300	CUMMINS C SERIES 8.3 L DIÉSEL	1993-1996
42352HD	KENWORTH	T300	CUMMINS C SERIES 8.3 L DIÉSEL	1995-1997
42352HD	MACK	CM SERIES	CUMMINS C SERIES 8.3 L DIÉSEL	1991-1992
42352HD	PETERBILT	200	CUMMINS C SERIES 8.3 L DIÉSEL	1993-1997
42352HD	PETERBILT	224	CUMMINS C SERIES 8.3 L DIÉSEL	1987-1992
42352HD	PETERBILT	227	CUMMINS C SERIES 8.3 L DIÉSEL	1990-1992
42352HD	PETERBILT	265	CUMMINS C SERIES 8.3 L DIÉSEL	1988-1992
42352HD	PETERBILT	320	CUMMINS C SERIES 8.3 L DIÉSEL	1988-1996
42352HD	PETERBILT	330	CUMMINS C SERIES 8.3 L DIÉSEL	1995-1996
42352HD	PETERBILT	357	CUMMINS C SERIES 8.3 L DIÉSEL	1988-1996
42352HD	PETERBILT	375	CUMMINS C SERIES 8.3 L DIÉSEL	1988-1996
42352HD	PETERBILT	376	CUMMINS C SERIES 8.3 L DIÉSEL	1988-1993
42352HD	PETERBILT	385	CUMMINS C SERIES 8.3 L DIÉSEL	1996-1996
42352HD	PETERBILT	13-210	CUMMINS C SERIES 8.3 L DIÉSEL	1988-1989
42352HD	PETERBILT	22-210	CUMMINS C SERIES 8.3 L DIÉSEL	1989-1989
43236HD	MACK	CH SERIES	MACK 6 CIL. 12.0 L DIÉSEL	2000-2002
43236HD	MACK	CH SERIES	MACK E7 DIÉSEL	2003-2003
43236HD	MACK	CH SERIES	MACK EM7 DIÉSEL	2003-2003
43240HD	MACK	CH SERIES	MACK 6 CIL. 12.0 L DIÉSEL	1889-1999
43307HD	FREIGHTLINER	CENTURY CLASS	CUMMINS M11 DIÉSEL	1996-1997
43307HD	FREIGHTLINER	FLA	CUMMINS L10 DIÉSEL	1991-1994
43307HD	FREIGHTLINER	FLB	CUMMINS L10 DIÉSEL	1995-1996
43307HD	FREIGHTLINER	FLB	CUMMINS M11 DIÉSEL	1995-1998
43307HD	FREIGHTLINER	FLC	CUMMINS L10 DIÉSEL	1991-1996
43307HD	FREIGHTLINER	FLC	CUMMINS M11 DIÉSEL	1995-1998
43307HD	FREIGHTLINER	FLD	CUMMINS ISM DIÉSEL	1998-1998
43307HD	FREIGHTLINER	FLD	CUMMINS L10 DIÉSEL	1991-1996
43307HD	FREIGHTLINER	FLD	CUMMINS M11 DIÉSEL	1995-1997
43307HD	INTERNATIONAL/NAVISTAR	2674	CUMMINS ISM DIÉSEL	2003-2003
43307HD	INTERNATIONAL/NAVISTAR	2674	CUMMINS L10 DIÉSEL	1991-1998
43307HD	INTERNATIONAL/NAVISTAR	2674	CUMMINS M11 DIÉSEL	1994-1997
43307HD	INTERNATIONAL/NAVISTAR	5500I	CUMMINS ISM DIÉSEL	2000-2007
43307HD	INTERNATIONAL/NAVISTAR	8100	CUMMINS L10 DIÉSEL	1991-1998

NO. PARTE

#	ARMADORA	MODELO	MOTOR	AÑOS	#	ARMADORA	MODELO	MOTOR	AÑOS
43307HD	INTERNATIONAL/NAVISTAR	8100	CUMMINS M11 DIÉSEL	1994-1997	43325HD	INTERNATIONAL/NAVISTAR	4700	NAVISTAR DT466 DIÉSEL	2002-2002
43307HD	INTERNATIONAL/NAVISTAR	8200	CUMMINS ISM DIÉSEL	1998-1998	43325HD	INTERNATIONAL/NAVISTAR	4800	NAVISTAR DT466 DIÉSEL	2002-2002
43307HD	INTERNATIONAL/NAVISTAR	8200	CUMMINS L10 DIÉSEL	1991-1997	43325HD	INTERNATIONAL/NAVISTAR	7300	NAVISTAR DT466 DIÉSEL	2005-2007
43307HD	INTERNATIONAL/NAVISTAR	8200	CUMMINS M11 DIÉSEL	1994-1997	43325HD	INTERNATIONAL/NAVISTAR	7400	NAVISTAR DT466 DIÉSEL	2003-2007
43307HD	INTERNATIONAL/NAVISTAR	8300	CUMMINS L10 DIÉSEL	1991-1994	43325HD	INTERNATIONAL/NAVISTAR	7400	NAVISTAR DT570 DIÉSEL	2005-2007
43307HD	INTERNATIONAL/NAVISTAR	9100	CUMMINS M11 DIÉSEL	1998-1998	43325HD	INTERNATIONAL/NAVISTAR	7500	NAVISTAR HT570 DIÉSEL	2005-2005
43307HD	INTERNATIONAL/NAVISTAR	9100I	CUMMINS ISM DIÉSEL	2000-2000	43325HD	INTERNATIONAL/NAVISTAR	DURASTAR 4300	NAVISTAR MAXXFORCE DT DIÉSEL	2008-2012
43307HD	INTERNATIONAL/NAVISTAR	9200	CUMMINS L10 DIÉSEL	1993-1994	43545HD	INTERNATIONAL/NAVISTAR	3800	NAVISTAR T444 DIÉSEL	2000-2004
43307HD	INTERNATIONAL/NAVISTAR	9200	CUMMINS M11 DIÉSEL	1994-1998	43545HD	INTERNATIONAL/NAVISTAR	4700	NAVISTAR T444 DIÉSEL	1996-2001
43307HD	INTERNATIONAL/NAVISTAR	9300	CUMMINS L10 DIÉSEL	1991-1994	43545HD	INTERNATIONAL/NAVISTAR	4800	NAVISTAR T444 DIÉSEL	1997-1997
43307HD	INTERNATIONAL/NAVISTAR	9300	CUMMINS M11 DIÉSEL	1993-1994	43545HD	INTERNATIONAL/NAVISTAR	4900	NAVISTAR T444 DIÉSEL	1997-1997
43307HD	INTERNATIONAL/NAVISTAR	9400	CUMMINS L10 DIÉSEL	1991-1994	43554HD	FREIGHTLINER	BUSINESS CLASS M2	CATERPILLAR 3126 DIÉSEL	2004-2004
43307HD	INTERNATIONAL/NAVISTAR	9400	CUMMINS M11 DIÉSEL	1995-1998	43554HD	FREIGHTLINER	FL50	CATERPILLAR 3126 DIÉSEL	2004-2004
43307HD	KENWORTH	T400	CUMMINS L10 DIÉSEL	1991-1997	43554HD	FREIGHTLINER	FL60	CATERPILLAR 3126 DIÉSEL	2002-2002
43307HD	KENWORTH	T400	CUMMINS M11 DIÉSEL	1995-1997	43554HD	FREIGHTLINER	FL60	CATERPILLAR 3126 DIÉSEL	2004-2004
43307HD	KENWORTH	T450	CUMMINS L10 DIÉSEL	1991-1995	43554HD	FREIGHTLINER	FL70	CATERPILLAR 3126 DIÉSEL	1998-2004
43307HD	KENWORTH	T450	CUMMINS M11 DIÉSEL	1995-1995	43554HD	FREIGHTLINER	FL80	CATERPILLAR 3126 DIÉSEL	2004-2004
43307HD	KENWORTH	T600	CUMMINS L10 DIÉSEL	1991-1995	43554HD	FREIGHTLINER	FS65	CATERPILLAR 3126 DIÉSEL	2003-2004
43307HD	KENWORTH	T600	CUMMINS M11 DIÉSEL	1995-1997	43561HD	FREIGHTLINER	BUSINESS CLASS M2	CATERPILLAR 3126 DIÉSEL	2007-2007
43307HD	KENWORTH	T800	CUMMINS L10 DIÉSEL	1991-1997	43561HD	FREIGHTLINER	BUSINESS CLASS M2	CATERPILLAR C7 DIÉSEL	2007-2007
43307HD	KENWORTH	T800	CUMMINS M11 DIÉSEL	1995-1997	43561HD	FREIGHTLINER	CONDOR	CATERPILLAR C7 DIÉSEL	2004-2005
43307HD	KENWORTH	W900	CUMMINS M11 DIÉSEL	1996-1997	43561HD	FREIGHTLINER	FL50	CATERPILLAR C7 DIÉSEL	2004-2004
43307HD	PETERBILT	357	CUMMINS L10 DIÉSEL	1991-1997	43561HD	FREIGHTLINER	FL60	CATERPILLAR C7 DIÉSEL	2004-2005
43307HD	PETERBILT	357	CUMMINS M11 DIÉSEL	1994-1997	43561HD	FREIGHTLINER	FL70	CATERPILLAR C7 DIÉSEL	2004-2005
43307HD	PETERBILT	375	CUMMINS L10 DIÉSEL	1991-1996	43561HD	FREIGHTLINER	FL80	CATERPILLAR C7 DIÉSEL	2004-2005
43307HD	PETERBILT	377	CUMMINS L10 DIÉSEL	1992-1997	43561HD	KENWORTH	T300	CATERPILLAR C7 DIÉSEL	2004-2007
43307HD	PETERBILT	377	CUMMINS M11 DIÉSEL	1997-1997	43564HD	CATERPILLAR	345C	CATERPILLAR 6 CIL. 763 DIÉSEL	*
43307HD	PETERBILT	378	CUMMINS L10 DIÉSEL	1988-1997	43564HD	CATERPILLAR	345C L	CATERPILLAR 6 CIL. 763 DIÉSEL	*
43307HD	PETERBILT	378	CUMMINS M11 DIÉSEL	1995-1997	43564HD	CATERPILLAR	345D	CATERPILLAR 6 CIL. 763 DIÉSEL	*
43325HD	INTERNATIONAL/NAVISTAR	4300	NAVISTAR DT466 DIÉSEL	2002-2007	43564HD	CATERPILLAR	345D L	CATERPILLAR 6 CIL. 763 DIÉSEL	*
43325HD	INTERNATIONAL/NAVISTAR	4300	NAVISTAR MAXXFORCE DT DIÉSEL	2008-2008	43564HD	CATERPILLAR	349D	CATERPILLAR 6 CIL. 763 DIÉSEL	*
43325HD	INTERNATIONAL/NAVISTAR	4400	NAVISTAR DT466 DIÉSEL	2002-2007	43564HD	CATERPILLAR	349D L	CATERPILLAR 6 CIL. 763 DIÉSEL	*
43325HD	INTERNATIONAL/NAVISTAR	4400	NAVISTAR DT570 DIÉSEL	2006-2007	43564HD	CATERPILLAR	W345C MH	CATERPILLAR 6 CIL. 763 DIÉSEL	*
43325HD	INTERNATIONAL/NAVISTAR	4400	NAVISTAR MAXXFORCE 9 DIÉSEL	2008-2008	43564HD	FREIGHTLINER	BUSINESS CLASS M2	CATERPILLAR C11 DIÉSEL	2004-2006
43325HD	INTERNATIONAL/NAVISTAR	4400	NAVISTAR MAXXFORCE DT DIÉSEL	2008-2008	43564HD	FREIGHTLINER	BUSINESS CLASS M2	CATERPILLAR C13 DIÉSEL	2004-2007
43325HD	INTERNATIONAL/NAVISTAR	4400	NAVISTAR MAXXFORCE DT DIÉSEL	2008-2008	43564HD	FREIGHTLINER	CENTURY CLASS	CATERPILLAR C13 DIÉSEL	2004-2007
43325HD	INTERNATIONAL/NAVISTAR	4400	NAVISTAR MAXXFORCE DT DIÉSEL	2008-2008	43564HD	FREIGHTLINER	CLASSIC	CATERPILLAR C13 DIÉSEL	2004-2007

*EN ESTAS APLICACIONES TOMAR COMO REFERENCIA EL TIPO DE MOTOR, YA QUE NO APLICA A UN RANGO DE AÑOS EN ESPECÍFICO.

#	ARMADORA	MODELO	MOTOR	AÑOS
43564HD	FREIGHTLINER	CLASSIC XL	CATERPILLAR C13 DIÉSEL	2004-2007
43564HD	FREIGHTLINER	COLUMBIA	CATERPILLAR C11 DIÉSEL	2004-2007
43564HD	FREIGHTLINER	COLUMBIA	CATERPILLAR C13 DIÉSEL	2004-2009
43564HD	FREIGHTLINER	CONDOR	CATERPILLAR C11 DIÉSEL	2005-2006
43564HD	FREIGHTLINER	CONDOR	CATERPILLAR C13 DIÉSEL	2004-2006
43564HD	FREIGHTLINER	FLD	CATERPILLAR C11 DIÉSEL	2004-2007
43564HD	FREIGHTLINER	FLD	CATERPILLAR C13 DIÉSEL	2004-2007
43564HD	INTERNATIONAL/ NAVISTAR	5500I	CATERPILLAR C13 DIÉSEL	2005-2007
43564HD	INTERNATIONAL/ NAVISTAR	5600I	CATERPILLAR C13 DIÉSEL	2005-2007
43564HD	INTERNATIONAL/ NAVISTAR	5900I	CATERPILLAR C13 DIÉSEL	2005-2007
43564HD	INTERNATIONAL/ NAVISTAR	7600	CATERPILLAR C13 DIÉSEL	2004-2007
43564HD	INTERNATIONAL/ NAVISTAR	7700	CATERPILLAR C13 DIÉSEL	2005-2007
43564HD	INTERNATIONAL/ NAVISTAR	8600	CATERPILLAR C13 DIÉSEL	2004-2007
43564HD	INTERNATIONAL/ NAVISTAR	9200I	CATERPILLAR C13 DIÉSEL	2004-2007
43564HD	INTERNATIONAL/ NAVISTAR	9400I	CATERPILLAR C13 DIÉSEL	2004-2007
43564HD	INTERNATIONAL/ NAVISTAR	9900I	CATERPILLAR C13 DIÉSEL	2004-2007
43564HD	KENWORTH	T800	CATERPILLAR C13 DIÉSEL	2004-2007
43564HD	KENWORTH	W900	CATERPILLAR C13 DIÉSEL	2004-2007
43564HD	PETERBILT	357	CATERPILLAR C13 DIÉSEL	2005-2007
43564HD	PETERBILT	378	CATERPILLAR C13 DIÉSEL	2005-2006
43564HD	PETERBILT	379	CATERPILLAR C13 DIÉSEL	2004-2007
43564HD	PETERBILT	385	CATERPILLAR C13 DIÉSEL	2005-2007
43564HD	PETERBILT	386	CATERPILLAR C13 DIÉSEL	2006-2007
43564HD	PETERBILT	387	CATERPILLAR C13 DIÉSEL	2004-2007
43564HD	STERLING	A LINE	CATERPILLAR C11 DIÉSEL	2005-2007
43564HD	STERLING	A LINE	CATERPILLAR C13 DIÉSEL	2004-2007
43564HD	STERLING	ACTERRA	CATERPILLAR C13 DIÉSEL	2004-2006
43564HD	STERLING	CONDOR	CATERPILLAR C11 DIÉSEL	2005-2005
43564HD	STERLING	CONDOR	CATERPILLAR C13 DIÉSEL	2004-2006
43564HD	STERLING	L LINE	CATERPILLAR C11 DIÉSEL	2004-2007
43564HD	STERLING	L LINE	CATERPILLAR C13 DIÉSEL	2004-2007
43566HD	FREIGHTLINER	FL80	CUMMINS ISC DIÉSEL	2000-2001
44051HD	FREIGHTLINER	CLASSIC	CATERPILLAR C16 DIÉSEL	2001-2003
44051HD	FREIGHTLINER	CLASSIC XL	CATERPILLAR C16 DIÉSEL	2001-2003
44051HD	FREIGHTLINER	COLUMBIA	CATERPILLAR C16 DIÉSEL	2001-2004
44051HD	FREIGHTLINER	CORONADO	CATERPILLAR C16 DIÉSEL	2002-2003
44051HD	FREIGHTLINER	FLD	CATERPILLAR C16 DIÉSEL	2000-2004
44051HD	INTERNATIONAL/ NAVISTAR	5900I	CATERPILLAR 3406 DIÉSEL	2003-2003
44051HD	INTERNATIONAL/ NAVISTAR	9200I	CATERPILLAR C16 DIÉSEL	2003-2003
44051HD	INTERNATIONAL/ NAVISTAR	9400I	CATERPILLAR C16 DIÉSEL	2000-2003

#	ARMADORA	MODELO	MOTOR	AÑOS
44051HD	INTERNATIONAL/ NAVISTAR	9900I	CATERPILLAR C16 DIÉSEL	2000-2003
44051HD	INTERNATIONAL/ NAVISTAR	9900IX	CATERPILLAR C16 DIÉSEL	2000-2002
44051HD	INTERNATIONAL/ NAVISTAR	PAYSTAR 5600I	CATERPILLAR C15 DIÉSEL	2009-2009
44051HD	KENWORTH	T800	CATERPILLAR C16 DIÉSEL	2000-2003
44051HD	KENWORTH	W900	CATERPILLAR C16 DIÉSEL	2000-2003
44051HD	PETERBILT	357	CATERPILLAR C16 DIÉSEL	2002-2002
44051HD	PETERBILT	377	CATERPILLAR C15 DIÉSEL	2000-2000
44051HD	PETERBILT	378	CATERPILLAR C16 DIÉSEL	2000-2001
44051HD	PETERBILT	379	CATERPILLAR C16 DIÉSEL	2000-2003
44052HD	FORD	L8000	CUMMINS N14 DIÉSEL	1993-1998
44052HD	FORD	L9000	CUMMINS 6 CIL. 14.0 L DIÉSEL	1990-1990
44052HD	FORD	L9000	CUMMINS N14 DIÉSEL	1991-1997
44052HD	FREIGHTLINER	CENTURY CLASS	CUMMINS N14 DIÉSEL	1996-2003
44052HD	FREIGHTLINER	CLASSIC	CUMMINS N14 DIÉSEL	2001-2002
44052HD	FREIGHTLINER	CLASSIC XL	CUMMINS N14 DIÉSEL	2001-2003
44052HD	FREIGHTLINER	COLUMBIA	CUMMINS N14 DIÉSEL	2001-2009
44052HD	FREIGHTLINER	FLA	CUMMINS 6 CIL. 14.0 L DIÉSEL	1990-1990
44052HD	FREIGHTLINER	FLA	CUMMINS N14 DIÉSEL	1991-1994
44052HD	FREIGHTLINER	FLB	CUMMINS N14 DIÉSEL	1994-1999
44052HD	FREIGHTLINER	FLC	CUMMINS 6 CIL. 14.0 L DIÉSEL	1990-1990
44052HD	FREIGHTLINER	FLC	CUMMINS N14 DIÉSEL	1991-1998
44052HD	FREIGHTLINER	FLD	CUMMINS 6 CIL. 14.0 L DIÉSEL	1990-1990
44052HD	FREIGHTLINER	FLD	CUMMINS N14 DIÉSEL	1991-2008
44052HD	FREIGHTLINER	FLL	CUMMINS N14 DIÉSEL	1995-1998
44052HD	INTERNATIONAL/ NAVISTAR	2554	CUMMINS N14 DIÉSEL	1999-2000
44052HD	INTERNATIONAL/ NAVISTAR	2574	CUMMINS 6 CIL. 14.0 L DIÉSEL	1990-1990
44052HD	INTERNATIONAL/ NAVISTAR	2574	CUMMINS N14 DIÉSEL	1991-2000
44052HD	INTERNATIONAL/ NAVISTAR	2654	CUMMINS N14 DIÉSEL	1999-2000
44052HD	INTERNATIONAL/ NAVISTAR	2674	CUMMINS 6 CIL. 14.0 L DIÉSEL	1990-1990
44052HD	INTERNATIONAL/ NAVISTAR	2674	CUMMINS N14 DIÉSEL	1991-2002
44052HD	INTERNATIONAL/ NAVISTAR	5000	CUMMINS 6 CIL. 14.0 L DIÉSEL	1990-1990
44052HD	INTERNATIONAL/ NAVISTAR	5000	CUMMINS N14 DIÉSEL	1991-1999
44052HD	INTERNATIONAL/ NAVISTAR	5500I	CUMMINS N14 DIÉSEL	2000-2003
44052HD	INTERNATIONAL/ NAVISTAR	5600I	CUMMINS N14 DIÉSEL	2000-2003
44052HD	INTERNATIONAL/ NAVISTAR	5900I	CUMMINS N14 DIÉSEL	2000-2003
44052HD	INTERNATIONAL/ NAVISTAR	8100	CUMMINS N14 DIÉSEL	1995-1999
44052HD	INTERNATIONAL/ NAVISTAR	8200	CUMMINS 6 CIL. 14.0 L DIÉSEL	1990-1990

#	ARMADORA	MODELO	MOTOR	AÑOS
44052HD	INTERNATIONAL/NAVISTAR	8200	CUMMINS N14 DIÉSEL	1991-1998
44052HD	INTERNATIONAL/NAVISTAR	8300	CUMMINS 6 CIL. 14.0 L DIÉSEL	1990-1990
44052HD	INTERNATIONAL/NAVISTAR	8300	CUMMINS N14 DIÉSEL	1991-1994
44052HD	INTERNATIONAL/NAVISTAR	9100	CUMMINS N14 DIÉSEL	1998-1999
44052HD	INTERNATIONAL/NAVISTAR	9100I	CUMMINS N14 DIÉSEL	2000-2003
44052HD	INTERNATIONAL/NAVISTAR	9200	CUMMINS N14 DIÉSEL	1995-1999
44052HD	INTERNATIONAL/NAVISTAR	9200I	CUMMINS N14 DIÉSEL	2000-2003
44052HD	INTERNATIONAL/NAVISTAR	9300	CUMMINS 6 CIL. 14.0 L DIÉSEL	1990-1990
44052HD	INTERNATIONAL/NAVISTAR	9300	CUMMINS N14 DIÉSEL	1991-1999
44052HD	INTERNATIONAL/NAVISTAR	9400	CUMMINS 6 CIL. 14.0 L DIÉSEL	1990-1990
44052HD	INTERNATIONAL/NAVISTAR	9400	CUMMINS N14 DIÉSEL	1991-1999
44052HD	INTERNATIONAL/NAVISTAR	9400I	CUMMINS N14 DIÉSEL	2000-2003
44052HD	INTERNATIONAL/NAVISTAR	9900	CUMMINS N14 DIÉSEL	1999-1999
44052HD	INTERNATIONAL/NAVISTAR	9900I	CUMMINS N14 DIÉSEL	2000-2003
44052HD	INTERNATIONAL/NAVISTAR	9900IX	CUMMINS N14 DIÉSEL	2000-2003
44052HD	JOHN DEERE	6950	CUMMINS N14 DIÉSEL	2004-2004
44052HD	KENWORTH	T2000	CUMMINS N14 DIÉSEL	1997-2001
44052HD	KENWORTH	T600	CUMMINS 6 CIL. 14.0 L DIÉSEL	1990-1991
44052HD	KENWORTH	T600	CUMMINS N14 DIÉSEL	1990-2001
44052HD	KENWORTH	T800	CUMMINS 6 CIL. 14.0 L DIÉSEL	1990-1991
44052HD	KENWORTH	T800	CUMMINS N14 DIÉSEL	1987-2003
44052HD	KENWORTH	W900	CUMMINS 6 CIL. 14.0 L DIÉSEL	1990-1991
44052HD	KENWORTH	W900	CUMMINS N14 DIÉSEL	1992-2003
44052HD	PETERBILT	357	CUMMINS 6 CIL. 14.0 L DIÉSEL	1990-1991
44052HD	PETERBILT	357	CUMMINS N14 DIÉSEL	1992-1997
44052HD	PETERBILT	377	CUMMINS 6 CIL. 14.0 L DIÉSEL	1990-1991
44052HD	PETERBILT	377	CUMMINS N14 DIÉSEL	1992-1999
44052HD	PETERBILT	378	CUMMINS 6 CIL. 14.0 L DIÉSEL	1990-1991
44052HD	PETERBILT	378	CUMMINS N14 DIÉSEL	1992-2003
44052HD	PETERBILT	379	CUMMINS 6 CIL. 14.0 L DIÉSEL	1990-1991
44052HD	PETERBILT	379	CUMMINS N14 DIÉSEL	1992-2003
44052HD	PETERBILT	385	CUMMINS N14 DIÉSEL	2002-2003
44052HD	VOLVO	VHD	CUMMINS N14 DIÉSEL	2001-2001
44052HD	VOLVO	VN SERIES	CUMMINS N14 DIÉSEL	1998-2003
44054HD	FORD	L8000	CATERPILLAR 3406 DIÉSEL	1994-1997
44054HD	FORD	L9000	CATERPILLAR 3406 DIÉSEL	1994-1997
44054HD	FREIGHTLINER	CENTURY CLASS	CATERPILLAR 3406 DIÉSEL	1996-1999

#	ARMADORA	MODELO	MOTOR	AÑOS
44054HD	FREIGHTLINER	CENTURY CLASS	CATERPILLAR 3406 DIÉSEL	2000-2000
44054HD	FREIGHTLINER	FLA	CATERPILLAR 3406 DIÉSEL	1993-1994
44054HD	FREIGHTLINER	FLB	CATERPILLAR 3406 DIÉSEL	1994-1997
44054HD	FREIGHTLINER	FLC	CATERPILLAR 3406 DIÉSEL	1993-1996
44054HD	FREIGHTLINER	FLD	CATERPILLAR 3406 DIÉSEL	1993-2000
44054HD	FREIGHTLINER	FLD	CATERPILLAR 3406 DIÉSEL	1996-1999
44054HD	FREIGHTLINER	FLL	CATERPILLAR 3406 DIÉSEL	1995-1996
44054HD	FREIGHTLINER	FLL	CATERPILLAR 3406 DIÉSEL	1997-1997
44054HD	INTERNATIONAL/NAVISTAR	5000	CATERPILLAR 3406 DIÉSEL	1996-1996
44054HD	INTERNATIONAL/NAVISTAR	7600	CATERPILLAR 3406 DIÉSEL	2003-2003
44054HD	INTERNATIONAL/NAVISTAR	8100	CATERPILLAR 3406 DIÉSEL	1996-1998
44054HD	INTERNATIONAL/NAVISTAR	8200	CATERPILLAR 3406 DIÉSEL	1993-1995
44054HD	INTERNATIONAL/NAVISTAR	8200	CATERPILLAR 3406 DIÉSEL	1996-1998
44054HD	INTERNATIONAL/NAVISTAR	8300	CATERPILLAR 3406 DIÉSEL	1993-1994
44054HD	INTERNATIONAL/NAVISTAR	9100	CATERPILLAR 3406 DIÉSEL	1998-1998
44054HD	INTERNATIONAL/NAVISTAR	9200	CATERPILLAR 3406 DIÉSEL	1995-1995
44054HD	INTERNATIONAL/NAVISTAR	9200	CATERPILLAR 3406 DIÉSEL	1996-1998
44054HD	INTERNATIONAL/NAVISTAR	9300	CATERPILLAR 3406 DIÉSEL	1993-1995
44054HD	INTERNATIONAL/NAVISTAR	9300	CATERPILLAR 3406 DIÉSEL	1996-1999
44054HD	INTERNATIONAL/NAVISTAR	9400	CATERPILLAR 3406 DIÉSEL	1993-1995
44054HD	INTERNATIONAL/NAVISTAR	9400	CATERPILLAR 3406 DIÉSEL	1996-1999
44054HD	INTERNATIONAL/NAVISTAR	9400I	CATERPILLAR 3406 DIÉSEL	2000-2000
44054HD	INTERNATIONAL/NAVISTAR	9900	CATERPILLAR 3406 DIÉSEL	1999-1999
44054HD	INTERNATIONAL/NAVISTAR	9900I	CATERPILLAR 3406 DIÉSEL	2000-2000
44054HD	INTERNATIONAL/NAVISTAR	9900IX	CATERPILLAR 3406 DIÉSEL	2000-2000
44054HD	KENWORTH	T2000	CATERPILLAR 3406 DIÉSEL	1997-2000
44054HD	KENWORTH	T600	CATERPILLAR 3406 DIÉSEL	1993-1995
44054HD	KENWORTH	T600	CATERPILLAR 3406 DIÉSEL	1996-1999
44054HD	KENWORTH	T800	CATERPILLAR 3406 DIÉSEL	1993-1995
44054HD	KENWORTH	T800	CATERPILLAR 3406 DIÉSEL	1996-2000
44054HD	KENWORTH	W900	CATERPILLAR 3406 DIÉSEL	1993-1995
44054HD	KENWORTH	W900	CATERPILLAR 3406 DIÉSEL	1996-2000
44054HD	MACK	CL SERIES	CATERPILLAR 3406 DIÉSEL	1995-1996
44054HD	MACK	CL SERIES	CATERPILLAR 3406 DIÉSEL	1998-1999
44054HD	PETERBILT	330	CATERPILLAR 3406 DIÉSEL	1999-2000
44054HD	PETERBILT	357	CATERPILLAR 3406 DIÉSEL	1993-1995
44054HD	PETERBILT	357	CATERPILLAR 3406 DIÉSEL	1996-1999

#	ARMADORA	MODELO	MOTOR	AÑOS
44054HD	PETERBILT	377	CATERPILLAR 3406 DIÉSEL	1993-1995
44054HD	PETERBILT	377	CATERPILLAR 3406 DIÉSEL	1996-1999
44054HD	PETERBILT	378	CATERPILLAR 3406 DIÉSEL	1993-1995
44054HD	PETERBILT	378	CATERPILLAR 3406 DIÉSEL	1996-1999
44054HD	PETERBILT	379	CATERPILLAR 3406 DIÉSEL	1993-1995
44054HD	PETERBILT	379	CATERPILLAR 3406 DIÉSEL	1996-2000
44054HD	VOLVO	VN SERIES	CATERPILLAR 3406 DIÉSEL	1997-1999
44057HD	FREIGHTLINER	114SD	DETROIT DIÉSEL DD13 DIÉSEL	2012-2019
44057HD	FREIGHTLINER	122SD	DETROIT DIÉSEL DD13 DIÉSEL	2014-2019
44057HD	FREIGHTLINER	122SD	DETROIT DIÉSEL DD15 DIÉSEL	2014-2019
44057HD	FREIGHTLINER	122SD	DETROIT DIÉSEL DD16 DIÉSEL	2014-2019
44057HD	FREIGHTLINER	BUSINESS CLASS M2	DETROIT DIÉSEL DD13 DIÉSEL	2010-2016
44057HD	FREIGHTLINER	BUSINESS CLASS M2	DETROIT DIÉSEL DD13 DIÉSEL	2017-2019
44057HD	FREIGHTLINER	CASCADIA	CUMMINS ISX15 DIÉSEL	2015-2015
44057HD	FREIGHTLINER	CASCADIA	DETROIT DIÉSEL DD13 DIÉSEL	2009-2013
44057HD	FREIGHTLINER	CASCADIA	DETROIT DIÉSEL DD13 DIÉSEL	2014-2018
44057HD	FREIGHTLINER	CASCADIA	DETROIT DIÉSEL DD15 DIÉSEL	2008-2013
44057HD	FREIGHTLINER	CASCADIA	DETROIT DIÉSEL DD15 DIÉSEL	2014-2016
44057HD	FREIGHTLINER	CASCADIA	DETROIT DIÉSEL DD16 DIÉSEL	2010-2019
44057HD	FREIGHTLINER	CENTURY CLASS	DETROIT DIÉSEL DD15 DIÉSEL	2008-2011
44057HD	FREIGHTLINER	COLUMBIA	DETROIT DIÉSEL DD13 DIÉSEL	2010-2011
44057HD	FREIGHTLINER	COLUMBIA	DETROIT DIÉSEL DD15 DIÉSEL	2008-2011
44057HD	FREIGHTLINER	CORONADO	DETROIT DIÉSEL DD13 DIÉSEL	2010-2016
44057HD	FREIGHTLINER	CORONADO	DETROIT DIÉSEL DD15 DIÉSEL	2010-2016
44057HD	FREIGHTLINER	CORONADO	DETROIT DIÉSEL DD16 DIÉSEL	2010-2016
44058HD	INTERNATIONAL/NAVISTAR	2554	NAVISTAR DT466 DIÉSEL	1986-1990
44058HD	INTERNATIONAL/NAVISTAR	2554	NAVISTAR DT466 DIÉSEL	1991-1991
44058HD	INTERNATIONAL/NAVISTAR	2654	NAVISTAR DT466 DIÉSEL	1989-1991
44058HD	INTERNATIONAL/NAVISTAR	2654	NAVISTAR DT466 DIÉSEL	1992-1993
44058HD	INTERNATIONAL/NAVISTAR	3800	NAVISTAR DT360 DIÉSEL	1990-1990
44058HD	INTERNATIONAL/NAVISTAR	4700	NAVISTAR DT360 DIÉSEL	1990-1994
44058HD	INTERNATIONAL/NAVISTAR	4800	NAVISTAR DT360 DIÉSEL	1990-1994
44058HD	INTERNATIONAL/NAVISTAR	4800	NAVISTAR DT466 DIÉSEL	1990-1990
44058HD	INTERNATIONAL/NAVISTAR	4800	NAVISTAR DT466 DIÉSEL	1991-1992
44058HD	INTERNATIONAL/NAVISTAR	4900	NAVISTAR DT360 DIÉSEL	1993-1993
44058HD	INTERNATIONAL/NAVISTAR	4900	NAVISTAR DT466 DIÉSEL	1990-1991
44058HD	INTERNATIONAL/NAVISTAR	4900	NAVISTAR DT466 DIÉSEL	1992-1992
44058HD	INTERNATIONAL/NAVISTAR	7100	NAVISTAR DT466 DIÉSEL	1990-1990

#	ARMADORA	MODELO	MOTOR	AÑOS
44058HD	INTERNATIONAL/NAVISTAR	7100	NAVISTAR DT466 DIÉSEL	1991-1995
44058HD	INTERNATIONAL/NAVISTAR	8100	NAVISTAR DT466 DIÉSEL	1990-1992
44058HD	INTERNATIONAL/NAVISTAR	8100	NAVISTAR DT466 DIÉSEL	1991-1991
44059HD	INTERNATIONAL/NAVISTAR	2554	NAVISTAR DT466 DIÉSEL	1991-1991
44059HD	INTERNATIONAL/NAVISTAR	2554	NAVISTAR DT466 DIÉSEL	1992-1995
44059HD	INTERNATIONAL/NAVISTAR	2654	NAVISTAR DT466 DIÉSEL	1992-1993
44059HD	INTERNATIONAL/NAVISTAR	3600	NAVISTAR DT466 DIÉSEL	1993-1994
44059HD	INTERNATIONAL/NAVISTAR	3700	NAVISTAR DT466 DIÉSEL	1993-1994
44059HD	INTERNATIONAL/NAVISTAR	3800	NAVISTAR DT466 DIÉSEL	1993-1994
44059HD	INTERNATIONAL/NAVISTAR	4700	NAVISTAR DT360 DIÉSEL	1990-1994
44059HD	INTERNATIONAL/NAVISTAR	4700	NAVISTAR DT466 DIÉSEL	1994-1994
44059HD	INTERNATIONAL/NAVISTAR	4800	NAVISTAR DT360 DIÉSEL	1990-1994
44059HD	INTERNATIONAL/NAVISTAR	4800	NAVISTAR DT466 DIÉSEL	1991-1992
44059HD	INTERNATIONAL/NAVISTAR	4800	NAVISTAR DT466 DIÉSEL	1993-1994
44059HD	INTERNATIONAL/NAVISTAR	4900	NAVISTAR DT360 DIÉSEL	1993-1993
44059HD	INTERNATIONAL/NAVISTAR	4900	NAVISTAR DT466 DIÉSEL	1992-1992
44059HD	INTERNATIONAL/NAVISTAR	4900	NAVISTAR DT466 DIÉSEL	1993-1994
44059HD	INTERNATIONAL/NAVISTAR	7100	NAVISTAR DT466 DIÉSEL	1991-1995
44059HD	INTERNATIONAL/NAVISTAR	8100	NAVISTAR DT466 DIÉSEL	1991-1991
44059HD	INTERNATIONAL/NAVISTAR	8100	NAVISTAR DT466 DIÉSEL	1993-1994
44060HD	CATERPILLAR	345B (2NW)	CATERPILLAR 3176TA DIÉSEL	*
44060HD	CATERPILLAR	345B (2ZW)	CATERPILLAR 3176TA DIÉSEL	*
44060HD	CATERPILLAR	345B (6MW)	CATERPILLAR 3176TA DIÉSEL	*
44060HD	CATERPILLAR	345B (6XS)	CATERPILLAR 3176TA DIÉSEL	*
44060HD	CATERPILLAR	345B (8KW)	CATERPILLAR 3176TA DIÉSEL	*
44060HD	CATERPILLAR	345B (AMD)	CATERPILLAR 3176TA DIÉSEL	*
44060HD	CATERPILLAR	345B (AMJ)	CATERPILLAR 3176TA DIÉSEL	*
44060HD	CATERPILLAR	345B (AMN)	CATERPILLAR 3176TA DIÉSEL	*
44060HD	CATERPILLAR	345B (AVR)	CATERPILLAR 3176TA DIÉSEL	*
44060HD	CATERPILLAR	345B (BFG)	CATERPILLAR 3176TA DIÉSEL	*
44060HD	CATERPILLAR	345B (CFM)	CATERPILLAR 3176C DIÉSEL	*
44060HD	CATERPILLAR	345B II (AGS)	CATERPILLAR 3176C DIÉSEL	*
44060HD	CATERPILLAR	345B II (AKJ)	CATERPILLAR 3176C DIÉSEL	*
44060HD	CATERPILLAR	345B II (AKX)	CATERPILLAR 3176C DIÉSEL	*
44060HD	CATERPILLAR	345B II (ALB)	CATERPILLAR 3176C DIÉSEL	*

*EN ESTAS APLICACIONES TOMAR COMO REFERENCIA EL TIPO DE MOTOR, YA QUE NO APLICA A UN RANGO DE AÑOS EN ESPECÍFICO.

#	ARMADORA	MODELO	MOTOR	AÑOS
44060HD	CATERPILLAR	345B II (ALD)	CATERPILLAR 3176C DIÉSEL	*
44060HD	CATERPILLAR	345B II (ALL)	CATERPILLAR 3176C DIÉSEL	*
44060HD	CATERPILLAR	345B II (CCC)	CATERPILLAR 3176C DIÉSEL	*
44060HD	CATERPILLAR	345B II (CDD)	CATERPILLAR 3176C DIÉSEL	*
44060HD	CATERPILLAR	345B II (DCM)	CATERPILLAR 3176C DIÉSEL	*
44060HD	CATERPILLAR	345B II (DET)	CATERPILLAR 3176C DIÉSEL	*
44060HD	CATERPILLAR	345B II (FEE)	CATERPILLAR 3176C DIÉSEL	*
44060HD	CATERPILLAR	345B II MH (APB)	CATERPILLAR 3176C DIÉSEL	*
44060HD	CATERPILLAR	345BL (ZSM)	CATERPILLAR 3176C DIÉSEL	*
44060HD	CATERPILLAR	345B L (3MW)	CATERPILLAR 3176C DIÉSEL	*
44060HD	CATERPILLAR	345BL (4SS)	CATERPILLAR 3176C DIÉSEL	*
44060HD	CATERPILLAR	345B L (5WS)	CATERPILLAR 3176C DIÉSEL	*
44060HD	CATERPILLAR	345B L (7KS)	CATERPILLAR 3176C DIÉSEL	*
44060HD	CATERPILLAR	345BL (8RM)	CATERPILLAR 3176C DIÉSEL	*
44060HD	CATERPILLAR	345BL (90W)	CATERPILLAR 3176C DIÉSEL	*
44060HD	CATERPILLAR	345BL (9GS)	CATERPILLAR 3176C DIÉSEL	*
44060HD	CATERPILLAR	365B (9PZ)	CATERPILLAR 3196 DIÉSEL	*
44060HD	CATERPILLAR	365B (9TZ)	CATERPILLAR 3196 DIÉSEL	*
44060HD	CATERPILLAR	365B (8TH)	CATERPILLAR 3196 DIÉSEL	*
44060HD	CATERPILLAR	365B (CFJ)	CATERPILLAR 3196 DIÉSEL	*
44060HD	CATERPILLAR	365B (CTY)	CATERPILLAR 3196 DIÉSEL	*
44060HD	CATERPILLAR	365B (PEG)	CATERPILLAR 3196 DIÉSEL	*
44060HD	CATERPILLAR	365B (SDL)	CATERPILLAR 3196 DIÉSEL	*
44060HD	CATERPILLAR	365B II (DER)	CATERPILLAR 3196 DIÉSEL	*
44060HD	CATERPILLAR	365B II (JMB)	CATERPILLAR 3196 DIÉSEL	*
44060HD	CATERPILLAR	365BL (4XZ)	CATERPILLAR 3196 DIÉSEL	*
44060HD	CATERPILLAR	365B L (9TZ)	CATERPILLAR 3196 DIÉSEL	*
44060HD	CATERPILLAR	365BL (AGD)	CATERPILLAR 3196 DIÉSEL	*
44060HD	CATERPILLAR	W345B II (ANJ)	CATERPILLAR 3176C DIÉSEL	2002-2007
44060HD	CATERPILLAR	W345B II (CDY)	CATERPILLAR 3176C DIÉSEL	2002-2007
44060HD	FREIGHTLINER	CENTURY CLASS	CATERPILLAR C12 DIÉSEL	2000-2004
44060HD	FREIGHTLINER	CLASSIC	CATERPILLAR C12 DIÉSEL	2001-2004
44060HD	FREIGHTLINER	CLASSIC XL	CATERPILLAR C12 DIÉSEL	2001-2003
44060HD	FREIGHTLINER	COLUMBIA	CATERPILLAR C10 DIÉSEL	2001-2001
44060HD	FREIGHTLINER	COLUMBIA	CATERPILLAR C12 DIÉSEL	2001-2004
44060HD	FREIGHTLINER	CONDOR	CATERPILLAR C10 DIÉSEL	2001-2001
44060HD	FREIGHTLINER	CONDOR	CATERPILLAR C12 DIÉSEL	2001-2005
44060HD	FREIGHTLINER	FL112	CATERPILLAR C12 DIÉSEL	2000-2003
44060HD	FREIGHTLINER	FLD	CATERPILLAR C10 DIÉSEL	2000-2000
44060HD	FREIGHTLINER	FLD	CATERPILLAR C12 DIÉSEL	2000-2004
44060HD	INTERNATIONAL/NAVISTAR	2554	CATERPILLAR C12 DIÉSEL	2003-2003
44060HD	INTERNATIONAL/NAVISTAR	2574	CATERPILLAR C10 DIÉSEL	2001-2001
44060HD	INTERNATIONAL/NAVISTAR	2574	CATERPILLAR C12 DIÉSEL	1999-2003

#	ARMADORA	MODELO	MOTOR	AÑOS
44060HD	INTERNATIONAL/NAVISTAR	2654	CATERPILLAR C12 DIÉSEL	2003-2003
44060HD	INTERNATIONAL/NAVISTAR	2674	CATERPILLAR C12 DIÉSEL	1999-2003
44060HD	INTERNATIONAL/NAVISTAR	5500I	CATERPILLAR C12 DIÉSEL	2000-2004
44060HD	INTERNATIONAL/NAVISTAR	5600I	CATERPILLAR C12 DIÉSEL	2000-2004
44060HD	INTERNATIONAL/NAVISTAR	5900I	CATERPILLAR C12 DIÉSEL	2000-2004
44060HD	INTERNATIONAL/NAVISTAR	7600	CATERPILLAR C12 DIÉSEL	2002-2004
44060HD	INTERNATIONAL/NAVISTAR	8600	CATERPILLAR C12 DIÉSEL	2002-2004
44060HD	INTERNATIONAL/NAVISTAR	9100I	CATERPILLAR C12 DIÉSEL	2000-2003
44060HD	INTERNATIONAL/NAVISTAR	9200I	CATERPILLAR C12 DIÉSEL	2000-2004
44060HD	INTERNATIONAL/NAVISTAR	9400I	CATERPILLAR C12 DIÉSEL	2000-2003
44060HD	INTERNATIONAL/NAVISTAR	9900I	CATERPILLAR C12 DIÉSEL	2000-2004
44060HD	INTERNATIONAL/NAVISTAR	9900IX	CATERPILLAR C12 DIÉSEL	2000-2003
44060HD	KENWORTH	T450	CATERPILLAR 3176 DIÉSEL	1994-1996
44060HD	KENWORTH	T600	CATERPILLAR C12 DIÉSEL	2000-2004
44060HD	KENWORTH	T800	CATERPILLAR C10 DIÉSEL	2000-2000
44060HD	KENWORTH	T800	CATERPILLAR C12 DIÉSEL	2000-2004
44060HD	KENWORTH	W900	CATERPILLAR C12 DIÉSEL	2000-2004
44060HD	PETERBILT	357	CATERPILLAR C12 DIÉSEL	2000-2004
44060HD	PETERBILT	378	CATERPILLAR C12 DIÉSEL	1997-2004
44060HD	PETERBILT	379	CATERPILLAR C12 DIÉSEL	1997-2004
44060HD	PETERBILT	385	CATERPILLAR C12 DIÉSEL	2000-2004
44060HD	PETERBILT	387	CATERPILLAR C12 DIÉSEL	2000-2003
44060HD	STERLING	CONDOR	CATERPILLAR C10 DIÉSEL	2002-2003
44060HD	STERLING	CONDOR	CATERPILLAR C12 DIÉSEL	2002-2003
44062HD	CATERPILLAR	365C (ELC)	CATERPILLAR C15 DIÉSEL	*
44062HD	CATERPILLAR	365C (FEN)	CATERPILLAR C15 DIÉSEL	*
44062HD	CATERPILLAR	365C (MCS)	CATERPILLAR C15 DIÉSEL	*
44062HD	CATERPILLAR	365C (MEM)	CATERPILLAR C15 DIÉSEL	*
44062HD	CATERPILLAR	365C (PAR)	CATERPILLAR C15 DIÉSEL	*
44062HD	CATERPILLAR	365C L (MCY)	CATERPILLAR C15 DIÉSEL	*
44062HD	CATERPILLAR	365C L MH (GWC)	CATERPILLAR C15 DIÉSEL	*
44062HD	CATERPILLAR	374D L (PAP)	CATERPILLAR C15 DIÉSEL	*
44062HD	CATERPILLAR	374D L (PAS)	CATERPILLAR C15 DIÉSEL	*
44062HD	CATERPILLAR	374D L (PAX)	CATERPILLAR C15 DIÉSEL	*
44062HD	CATERPILLAR	374D L (PAJ)	CATERPILLAR C15 DIÉSEL	*
44062HD	CATERPILLAR	385C (JCM)	CATERPILLAR C18 DIÉSEL	*
44062HD	CATERPILLAR	385C (KBC)	CATERPILLAR C18 DIÉSEL	*
44062HD	CATERPILLAR	385C (KVK)	CATERPILLAR C18 DIÉSEL	*
44062HD	CATERPILLAR	385C (MNZ)	CATERPILLAR C18 DIÉSEL	*

*EN ESTAS APLICACIONES TOMAR COMO REFERENCIA EL TIPO DE MOTOR, YA QUE NO APLICA A UN RANGO DE AÑOS EN ESPECÍFICO.

#	ARMADORA	MODELO	MOTOR	AÑOS
44062HD	CATERPILLAR	385C FS (EAM)	CATERPILLAR C18 DIÉSEL	*
44062HD	CATERPILLAR	385C FS (T2F)	CATERPILLAR C18 DIÉSEL	*
44062HD	CATERPILLAR	385CL(EDA)	CATERPILLAR C18 DIÉSEL	*
44062HD	CATERPILLAR	385CL(KGB)	CATERPILLAR C18 DIÉSEL	*
44062HD	CATERPILLAR	385CL(SBE)	CATERPILLAR C18 DIÉSEL	*
44062HD	CATERPILLAR	385CL(T2E)	CATERPILLAR C18 DIÉSEL	*
44062HD	CATERPILLAR	385C L MH (WAW)	CATERPILLAR C18 DIÉSEL	*
44062HD	CATERPILLAR	390D (BYP)	CATERPILLAR C18 DIÉSEL	*
44062HD	CATERPILLAR	390D (KQZ)	CATERPILLAR C18 DIÉSEL	*
44062HD	CATERPILLAR	390D L (WAG)	CATERPILLAR C18 DIÉSEL	*
44062HD	CATERPILLAR	390D L (WAF)	CATERPILLAR C18 DIÉSEL	*
44062HD	CATERPILLAR	390D L (WBT)	CATERPILLAR C18 DIÉSEL	*
44062HD	FREIGHTLINER	CASCADIA	CATERPILLAR C15 DIÉSEL	2008-2009
44062HD	FREIGHTLINER	CENTURY CLASS	CATERPILLAR C15 DIÉSEL	2001-2009
44062HD	FREIGHTLINER	CLASSIC	CATERPILLAR C15 DIÉSEL	2001-2009
44062HD	FREIGHTLINER	CLASSIC XL	CATERPILLAR C15 DIÉSEL	2001-2009
44062HD	FREIGHTLINER	COLUMBIA	CATERPILLAR C15 DIÉSEL	2001-2009
44062HD	FREIGHTLINER	CORONADO	CATERPILLAR C15 DIÉSEL	2001-2009
44062HD	FREIGHTLINER	FLD	CATERPILLAR C15 DIÉSEL	2000-2010
44062HD	INTERNATIONAL/NAVISTAR	5500I	CATERPILLAR C15 DIÉSEL	2006-2007
44062HD	INTERNATIONAL/NAVISTAR	5600I	CATERPILLAR C15 DIÉSEL	2004-2007
44062HD	INTERNATIONAL/NAVISTAR	5900I	CATERPILLAR C15 DIÉSEL	2004-2007
44062HD	INTERNATIONAL/NAVISTAR	9200I	CATERPILLAR C15 DIÉSEL	2003-2004
44062HD	INTERNATIONAL/NAVISTAR	9400I	CATERPILLAR C15 DIÉSEL	2000-2007
44062HD	INTERNATIONAL/NAVISTAR	9900I	CATERPILLAR C15 DIÉSEL	2000-2007
44062HD	INTERNATIONAL/NAVISTAR	9900IX	CATERPILLAR C15 DIÉSEL	2000-2007
44062HD	INTERNATIONAL/NAVISTAR	PAYSTAR 5600I	CATERPILLAR C15 DIÉSEL	2008-2008
44062HD	INTERNATIONAL/NAVISTAR	PROSTAR SERIES	CATERPILLAR C15 DIÉSEL	2008-2009
44062HD	KENWORTH	T2000	CATERPILLAR C15 DIÉSEL	2000-2007
44062HD	KENWORTH	T600	CATERPILLAR C15 DIÉSEL	2000-2008
44062HD	KENWORTH	T660	CATERPILLAR C15 DIÉSEL	2007-2011
44062HD	KENWORTH	T800	CATERPILLAR C15 DIÉSEL	2000-2009
44062HD	KENWORTH	T800	CATERPILLAR C15 DIÉSEL	2006-2006
44062HD	KENWORTH	W900	CATERPILLAR C15 DIÉSEL	2000-2010
44062HD	PETERBILT	357	CATERPILLAR C15 DIÉSEL	2000-2007
44062HD	PETERBILT	367	CATERPILLAR C15 DIÉSEL	2008-2011
44062HD	PETERBILT	378	CATERPILLAR C15 DIÉSEL	2000-2007
44062HD	PETERBILT	379	CATERPILLAR C15 DIÉSEL	2000-2007
44062HD	PETERBILT	386	CATERPILLAR C15 DIÉSEL	2006-2010
44062HD	PETERBILT	387	CATERPILLAR C15 DIÉSEL	2001-2008

#	ARMADORA	MODELO	MOTOR	AÑOS
44062HD	PETERBILT	388	CATERPILLAR C15 DIÉSEL	2007-2011
44066HD	FORD	L8000	DETROIT DIÉSEL SERIES 60 DIÉSEL	1996-1998
44066HD	FORD	L9000	DETROIT DIÉSEL 6 CIL. 11.1 L DIÉSEL	1994-1997
44066HD	FORD	L9000	DETROIT DIÉSEL 6 CIL. 12.7 L DIÉSEL	1996-1997
44066HD	FORD	L9000	DETROIT DIÉSEL SERIES 60 DIÉSEL	1991-1993
44066HD	FREIGHTLINER	CENTURY CLASS	DETROIT DIÉSEL 6 CIL. 11.1 L DIÉSEL	1996-2003
44066HD	FREIGHTLINER	CENTURY CLASS	DETROIT DIÉSEL 6 CIL. 12.7 L DIÉSEL	1996-2007
44066HD	FREIGHTLINER	CENTURY CLASS	DETROIT DIÉSEL 6 CIL. 14.0 L DIÉSEL	2003-2007
44066HD	FREIGHTLINER	CENTURY CLASS	DETROIT DIÉSEL SERIES 55 DIÉSEL	1996-1998
44066HD	FREIGHTLINER	CLASSIC	DETROIT DIÉSEL 6 CIL. 11.1 L DIÉSEL	2001-2002
44066HD	FREIGHTLINER	CLASSIC	DETROIT DIÉSEL 6 CIL. 12.7 L DIÉSEL	2001-2007
44066HD	FREIGHTLINER	CLASSIC	DETROIT DIÉSEL 6 CIL. 14.0 L DIÉSEL	2003-2007
44066HD	FREIGHTLINER	CLASSIC XL	DETROIT DIÉSEL 6 CIL. 11.1 L DIÉSEL	2001-2002
44066HD	FREIGHTLINER	CLASSIC XL	DETROIT DIÉSEL 6 CIL. 12.7 L DIÉSEL	2001-2007
44066HD	FREIGHTLINER	CLASSIC XL	DETROIT DIÉSEL 6 CIL. 14.0 L DIÉSEL	2001-2007
44066HD	FREIGHTLINER	COLUMBIA	DETROIT DIÉSEL 6 CIL. 11.1 L DIÉSEL	2000-2001
44066HD	FREIGHTLINER	COLUMBIA	DETROIT DIÉSEL 6 CIL. 12.7 L DIÉSEL	2000-2008
44066HD	FREIGHTLINER	COLUMBIA	DETROIT DIÉSEL 6 CIL. 14.0 L DIÉSEL	2002-2007
44066HD	FREIGHTLINER	CORONADO	DETROIT DIÉSEL 6 CIL. 12.7 L DIÉSEL	2002-2009
44066HD	FREIGHTLINER	CORONADO	DETROIT DIÉSEL 6 CIL. 14.0 L DIÉSEL	2003-2007
44066HD	FREIGHTLINER	FL106	DETROIT DIÉSEL SERIES 50 DIÉSEL	1994-2001
44066HD	FREIGHTLINER	FL112	DETROIT DIÉSEL SERIES 55 DIÉSEL	1997-1998
44066HD	FREIGHTLINER	FLA	DETROIT DIÉSEL 6 CIL. 11.1 L DIÉSEL	1991-1994
44066HD	FREIGHTLINER	FLA	DETROIT DIÉSEL 6 CIL. 12.7 L DIÉSEL	1991-1994
44066HD	FREIGHTLINER	FLB	DETROIT DIÉSEL 6 CIL. 11.1 L DIÉSEL	1994-1999
44066HD	FREIGHTLINER	FLB	DETROIT DIÉSEL 6 CIL. 12.7 L DIÉSEL	1994-1999
44066HD	FREIGHTLINER	FLC	DETROIT DIÉSEL 6 CIL. 11.1 L DIÉSEL	1991-2000
44066HD	FREIGHTLINER	FLC	DETROIT DIÉSEL 6 CIL. 12.7 L DIÉSEL	1991-1998
44066HD	FREIGHTLINER	FLD	DETROIT DIÉSEL 6 CIL. 11.1 L DIÉSEL	1991-2002
44066HD	FREIGHTLINER	FLD	DETROIT DIÉSEL 6 CIL. 12.7 L DIÉSEL	1991-2008
44066HD	FREIGHTLINER	FLD	DETROIT DIÉSEL 6 CIL. 14.0 L DIÉSEL	2001-2007
44066HD	FREIGHTLINER	FLD	DETROIT DIÉSEL SERIES 50 DIÉSEL	1994-1996
44066HD	FREIGHTLINER	FLL	DETROIT DIÉSEL 6 CIL. 11.1 L DIÉSEL	1995-1998
44066HD	FREIGHTLINER	FLL	DETROIT DIÉSEL 6 CIL. 12.7 L DIÉSEL	1990-1998
44066HD	FREIGHTLINER	FLS112	DETROIT DIÉSEL 6 CIL. 11.1 L DIÉSEL	2000-2000
44066HD	FREIGHTLINER	FLS112	DETROIT DIÉSEL 6 CIL. 12.7 L DIÉSEL	2000-2000
44066HD	INTERNATIONAL/NAVISTAR	8100	DETROIT DIÉSEL 6 CIL. 11.1 L DIÉSEL	1991-1996
44066HD	INTERNATIONAL/NAVISTAR	8100	DETROIT DIÉSEL 6 CIL. 12.7 L DIÉSEL	1991-1996
44066HD	INTERNATIONAL/NAVISTAR	8100	DETROIT DIÉSEL SERIES 50 DIÉSEL	1994-1998
44066HD	INTERNATIONAL/NAVISTAR	8200	DETROIT DIÉSEL 6 CIL. 11.1 L DIÉSEL	1991-1998
44066HD	INTERNATIONAL/NAVISTAR	8200	DETROIT DIÉSEL 6 CIL. 12.7 L DIÉSEL	1991-1996
44066HD	INTERNATIONAL/NAVISTAR	8200	DETROIT DIÉSEL SERIES 50 DIÉSEL	1997-1997

*EN ESTAS APLICACIONES TOMAR COMO REFERENCIA EL TIPO DE MOTOR, YA QUE NO APLICA A UN RANGO DE AÑOS EN ESPECÍFICO.

NO. PARTE

#	ARMADORA	MODELO	MOTOR	AÑOS
44066HD	INTERNATIONAL/NAVISTAR	8200	DETROIT DIÉSEL SERIES 60 DIÉSEL	1997-1997
44066HD	INTERNATIONAL/NAVISTAR	8300	DETROIT DIÉSEL 6 CIL. 11.1 L DIÉSEL	1991-1994
44066HD	INTERNATIONAL/NAVISTAR	8300	DETROIT DIÉSEL 6 CIL. 12.7 L DIÉSEL	1991-1994
44066HD	INTERNATIONAL/NAVISTAR	9100	DETROIT DIÉSEL SERIES 60 DIÉSEL	1998-1999
44066HD	INTERNATIONAL/NAVISTAR	9100I	DETROIT DIÉSEL 6 CIL. 12.7 L DIÉSEL	2001-2003
44066HD	INTERNATIONAL/NAVISTAR	9100I	DETROIT DIÉSEL SERIES 60 DIÉSEL	2000-2000
44066HD	INTERNATIONAL/NAVISTAR	9200	DETROIT DIÉSEL 6 CIL. 11.1 L DIÉSEL	1994-1997
44066HD	INTERNATIONAL/NAVISTAR	9200	DETROIT DIÉSEL 6 CIL. 12.7 L DIÉSEL	1994-1997
44066HD	INTERNATIONAL/NAVISTAR	9200	DETROIT DIÉSEL SERIES 60 DIÉSEL	1998-1999
44066HD	INTERNATIONAL/NAVISTAR	9200I	DETROIT DIÉSEL 6 CIL. 12.7 L DIÉSEL	2001-2003
44066HD	INTERNATIONAL/NAVISTAR	9200I	DETROIT DIÉSEL SERIES 60 DIÉSEL	2000-2000
44066HD	INTERNATIONAL/NAVISTAR	9300	DETROIT DIÉSEL 6 CIL. 11.1 L DIÉSEL	1992-1997
44066HD	INTERNATIONAL/NAVISTAR	9300	DETROIT DIÉSEL 6 CIL. 12.7 L DIÉSEL	1992-1999
44066HD	INTERNATIONAL/NAVISTAR	9300	DETROIT DIÉSEL SERIES 60 DIÉSEL	1998-1998
44066HD	INTERNATIONAL/NAVISTAR	9400	DETROIT DIÉSEL 6 CIL. 11.1 L DIÉSEL	1995-1996
44066HD	INTERNATIONAL/NAVISTAR	9400	DETROIT DIÉSEL 6 CIL. 12.7 L DIÉSEL	1995-1996
44066HD	INTERNATIONAL/NAVISTAR	9400	DETROIT DIÉSEL SERIES 60 DIÉSEL	1992-1999
44066HD	INTERNATIONAL/NAVISTAR	9400I	DETROIT DIÉSEL 6 CIL. 12.7 L DIÉSEL	2001-2003
44066HD	INTERNATIONAL/NAVISTAR	9400I	DETROIT DIÉSEL SERIES 60 DIÉSEL	2000-2000
44066HD	INTERNATIONAL/NAVISTAR	9900	DETROIT DIÉSEL SERIES 60 DIÉSEL	1999-1999
44066HD	INTERNATIONAL/NAVISTAR	9900I	DETROIT DIÉSEL 6 CIL. 12.7 L DIÉSEL	2001-2003
44066HD	INTERNATIONAL/NAVISTAR	9900I	DETROIT DIÉSEL SERIES 60 DIÉSEL	2000-2000
44066HD	INTERNATIONAL/NAVISTAR	9900IX	DETROIT DIÉSEL 6 CIL. 12.7 L DIÉSEL	2001-2002
44066HD	INTERNATIONAL/NAVISTAR	9900IX	DETROIT DIÉSEL SERIES 60 DIÉSEL	2000-2000
44066HD	KENWORTH	C500	DETROIT DIÉSEL 6 CIL. 11.1 L DIÉSEL	1991-1994
44066HD	KENWORTH	C500	DETROIT DIÉSEL 6 CIL. 12.7 L DIÉSEL	1991-1994
44066HD	KENWORTH	T2000	DETROIT DIÉSEL 6 CIL. 11.1 L DIÉSEL	1997-2000
44066HD	KENWORTH	T2000	DETROIT DIÉSEL 6 CIL. 12.7 L DIÉSEL	1997-2003
44066HD	KENWORTH	T600	DETROIT DIÉSEL 6 CIL. 11.1 L DIÉSEL	1991-1999
44066HD	KENWORTH	T600	DETROIT DIÉSEL 6 CIL. 12.7 L DIÉSEL	1991-2003
44066HD	KENWORTH	T800	DETROIT DIÉSEL 6 CIL. 11.1 L DIÉSEL	1991-2001
44066HD	KENWORTH	T800	DETROIT DIÉSEL 6 CIL. 12.7 L DIÉSEL	1991-2003
44066HD	KENWORTH	W900	DETROIT DIÉSEL 6 CIL. 11.1 L DIÉSEL	1991-2006

#	ARMADORA	MODELO	MOTOR	AÑOS
44066HD	KENWORTH	W900	DETROIT DIÉSEL 6 CIL. 12.7 L DIÉSEL	1991-2006
44066HD	MACK	CH SERIES	DETROIT DIÉSEL 6 CIL. 12.7 L DIÉSEL	1993-1993
44066HD	MACK	CL SERIES	DETROIT DIÉSEL 6 CIL. 12.7 L DIÉSEL	1992-2002
44066HD	MARCOPOLO	VIAGGIO 1000	DETROIT DIÉSEL SERIES 60 DIÉSEL	1996-1996
44066HD	PETERBILT	357	DETROIT DIÉSEL 6 CIL. 11.1 L DIÉSEL	1992-1999
44066HD	PETERBILT	357	DETROIT DIÉSEL 6 CIL. 12.7 L DIÉSEL	1989-2003
44066HD	PETERBILT	377	DETROIT DIÉSEL 6 CIL. 11.1 L DIÉSEL	1992-2000
44066HD	PETERBILT	377	DETROIT DIÉSEL 6 CIL. 12.7 L DIÉSEL	1988-2001
44066HD	PETERBILT	378	DETROIT DIÉSEL 6 CIL. 11.1 L DIÉSEL	1992-1999
44066HD	PETERBILT	378	DETROIT DIÉSEL 6 CIL. 12.7 L DIÉSEL	1988-2004
44066HD	PETERBILT	379	DETROIT DIÉSEL 6 CIL. 11.1 L DIÉSEL	1992-2001
44066HD	PETERBILT	379	DETROIT DIÉSEL 6 CIL. 12.7 L DIÉSEL	1988-2003
44066HD	PETERBILT	385	DETROIT DIÉSEL 6 CIL. 12.7 L DIÉSEL	2001-2003
44066HD	PETERBILT	387	DETROIT DIÉSEL 6 CIL. 12.7 L DIÉSEL	2001-2001
44066HD	VOLVO	AUTOHAULER	DETROIT DIÉSEL 6 CIL. 11.1 L DIÉSEL	1996-2001
44066HD	VOLVO	AUTOHAULER	DETROIT DIÉSEL 6 CIL. 12.7 L DIÉSEL	1997-2001
44066HD	VOLVO	AUTOHAULER	DETROIT DIÉSEL SERIES 60 DIÉSEL	1991-1993
44066HD	VOLVO	VHD	DETROIT DIÉSEL SERIES 60 DIÉSEL	2001-2001
44066HD	VOLVO	VN SERIES	DETROIT DIÉSEL 6 CIL. 11.1 L DIÉSEL	1998-2002
44066HD	VOLVO	VN SERIES	DETROIT DIÉSEL 6 CIL. 12.7 L DIÉSEL	1998-2003
44092HD	FORD	L9000	CUMMINS 6 CIL. 14.0 L DIÉSEL	1985-1985
44092HD	FORD	L9000	CUMMINS 6 CIL. 14.0 L DIÉSEL	1986-1989
44092HD	FREIGHTLINER	FLA	CUMMINS 6 CIL. 14.0 L DIÉSEL	1989-1989
44092HD	FREIGHTLINER	FLC	CUMMINS 6 CIL. 14.0 L DIÉSEL	1985-1985
44092HD	FREIGHTLINER	FLC	CUMMINS 6 CIL. 14.0 L DIÉSEL	1986-1989
44092HD	FREIGHTLINER	FLD	CUMMINS 6 CIL. 14.0 L DIÉSEL	1988-1989
44092HD	FREIGHTLINER	FLT	CUMMINS 6 CIL. 14.0 L DIÉSEL	1985-1985
44092HD	FREIGHTLINER	FLT	CUMMINS 6 CIL. 14.0 L DIÉSEL	1986-1988
44092HD	INTERNATIONAL/NAVISTAR	2574	CUMMINS 6 CIL. 14.0 L DIÉSEL	1985-1985
44092HD	INTERNATIONAL/NAVISTAR	2574	CUMMINS 6 CIL. 14.0 L DIÉSEL	1986-1989
44092HD	INTERNATIONAL/NAVISTAR	2674	CUMMINS 6 CIL. 14.0 L DIÉSEL	1985-1985
44092HD	INTERNATIONAL/NAVISTAR	2674	CUMMINS 6 CIL. 14.0 L DIÉSEL	1986-1989
44092HD	INTERNATIONAL/NAVISTAR	8300	CUMMINS 6 CIL. 14.0 L DIÉSEL	1988-1989
44092HD	INTERNATIONAL/NAVISTAR	9300	CUMMINS 6 CIL. 14.0 L DIÉSEL	1988-1989
44092HD	KENWORTH	T600	CUMMINS 6 CIL. 14.0 L DIÉSEL	1986-1989
44092HD	KENWORTH	T800	CUMMINS 6 CIL. 14.0 L DIÉSEL	1987-1989
44092HD	KENWORTH	W900	CUMMINS 6 CIL. 14.0 L DIÉSEL	1985-1985
44092HD	KENWORTH	W900	CUMMINS 6 CIL. 14.0 L DIÉSEL	1986-1989
44092HD	PETERBILT	357	CUMMINS 6 CIL. 14.0 L DIÉSEL	1987-1989
44092HD	PETERBILT	377	CUMMINS 6 CIL. 14.0 L DIÉSEL	1987-1989
44092HD	PETERBILT	378	CUMMINS 6 CIL. 14.0 L DIÉSEL	1988-1989
44092HD	PETERBILT	379	CUMMINS 6 CIL. 14.0 L DIÉSEL	1987-1989

#	ARMADORA	MODELO	MOTOR	AÑOS
45050HD	FREIGHTLINER	BUSINESS CLASS M2	MERCEDES-BENZ MBE 900 DIÉSEL	2006-2015
45050HD	FREIGHTLINER	BUSINESS CLASS M2	MERCEDES-BENZ OM906 DIÉSEL	2006-2006
45050HD	FREIGHTLINER	FL70	MERCEDES-BENZ MBE 900 DIÉSEL	2003-2005
45050HD	FREIGHTLINER	FLD	MERCEDES-BENZ MBE 4000 DIÉSEL	2005-2006
45050HD	FREIGHTLINER	FS65	MERCEDES-BENZ MBE 900 DIÉSEL	2005-2005
45051HD	FREIGHTLINER	CENTURY CLASS	CUMMINS ISX DIÉSEL	2003-2003
45051HD	FREIGHTLINER	COLUMBIA	CUMMINS ISX DIÉSEL	2002-2003
45051HD	KENWORTH	T600	CUMMINS ISX DIÉSEL	2002-2003
45051HD	KENWORTH	T800	CUMMINS ISX DIÉSEL	2001-2001
45051HD	KENWORTH	W900	CUMMINS ISX DIÉSEL	2000-2000
45051HD	PETERBILT	357	CUMMINS ISX DIÉSEL	2006-2006
45051HD	PETERBILT	378	CUMMINS ISX DIÉSEL	2006-2006
45051HD	PETERBILT	379	CUMMINS ISX DIÉSEL	2006-2006
45051HD	PETERBILT	387	CUMMINS ISX DIÉSEL	2006-2006
45052HD	FREIGHTLINER	122SD	CUMMINS ISX15 DIÉSEL	2014-2017
45052HD	FREIGHTLINER	CASCADIA	CUMMINS ISX DIÉSEL	2009-2009
45052HD	FREIGHTLINER	CASCADIA	CUMMINS ISX15 DIÉSEL	2010-2016
45052HD	FREIGHTLINER	CORONADO	CUMMINS ISX15 DIÉSEL	2010-2016
45052HD	INTERNATIONAL/NAVISTAR	5500I	CUMMINS ISL DIÉSEL	2007-2007
45052HD	INTERNATIONAL/NAVISTAR	9200I	CUMMINS ISX DIÉSEL	2008-2011
45052HD	INTERNATIONAL/NAVISTAR	9900I	CUMMINS ISX DIÉSEL	2008-2008
45052HD	INTERNATIONAL/NAVISTAR	9900I	CUMMINS ISX15 DIÉSEL	2014-2017
45052HD	INTERNATIONAL/NAVISTAR	HX SERIES	CUMMINS ISX15 DIÉSEL	2016-2017
45052HD	INTERNATIONAL/NAVISTAR	LONESTAR	CUMMINS ISX DIÉSEL	2009-2011
45052HD	INTERNATIONAL/NAVISTAR	LONESTAR	CUMMINS ISX15 DIÉSEL	2014-2017
45052HD	INTERNATIONAL/NAVISTAR	PAYSTAR 5500I	CUMMINS ISX DIÉSEL	2008-2011
45052HD	INTERNATIONAL/NAVISTAR	PAYSTAR 5600I	CUMMINS ISX DIÉSEL	2008-2011
45052HD	INTERNATIONAL/NAVISTAR	PAYSTAR 5900I	CUMMINS ISX DIÉSEL	2008-2011
45052HD	INTERNATIONAL/NAVISTAR	PAYSTAR 5900I	CUMMINS ISX15 DIÉSEL	2014-2016
45052HD	INTERNATIONAL/NAVISTAR	PROSTAR SERIES	CUMMINS ISX DIÉSEL	2008-2011
45052HD	INTERNATIONAL/NAVISTAR	PROSTAR SERIES	CUMMINS ISX15 DIÉSEL	2013-2016
45052HD	KENWORTH	C500	CUMMINS ISX15 DIÉSEL	2010-2015
45052HD	KENWORTH	T2000	CUMMINS ISX DIÉSEL	2009-2009
45052HD	KENWORTH	T660	CUMMINS ISX DIÉSEL	2008-2009
45052HD	KENWORTH	T660	CUMMINS ISX15 DIÉSEL	2010-2015
45052HD	KENWORTH	T680	CUMMINS ISX15 DIÉSEL	2013-2017
45052HD	KENWORTH	T700	CUMMINS ISX15 DIÉSEL	2011-2015
45052HD	KENWORTH	T800	CUMMINS ISX DIÉSEL	2009-2009

#	ARMADORA	MODELO	MOTOR	AÑOS
45052HD	KENWORTH	T800	CUMMINS ISX15 DIÉSEL	2010-2016
45052HD	KENWORTH	T880	CUMMINS ISX15 DIÉSEL	2014-2017
45052HD	KENWORTH	W900	CUMMINS ISX DIÉSEL	2009-2009
45052HD	KENWORTH	W900	CUMMINS ISX15 DIÉSEL	2010-2017
45052HD	PETERBILT	357	CUMMINS ISX DIÉSEL	2007-2007
45052HD	PETERBILT	367	CUMMINS ISX DIÉSEL	2007-2009
45052HD	PETERBILT	367	CUMMINS ISX15 DIÉSEL	2010-2016
45052HD	PETERBILT	378	CUMMINS ISX DIÉSEL	2007-2007
45052HD	PETERBILT	385	CUMMINS ISX DIÉSEL	2007-2007
45052HD	PETERBILT	386	CUMMINS ISX DIÉSEL	2008-2009
45052HD	PETERBILT	386	CUMMINS ISX15 DIÉSEL	2010-2014
45052HD	PETERBILT	387	CUMMINS ISX DIÉSEL	2008-2009
45052HD	PETERBILT	387	CUMMINS ISX15 DIÉSEL	2010-2011
45052HD	PETERBILT	388	CUMMINS ISX DIÉSEL	2008-2008
45052HD	PETERBILT	388	CUMMINS ISX15 DIÉSEL	2010-2015
45052HD	PETERBILT	388	CUMMINS ISX-G LNG	2011-2011
45052HD	PETERBILT	567	CUMMINS ISX15 DIÉSEL	2016-2017
45052HD	PETERBILT	579	CUMMINS ISX15 DIÉSEL	2015-2016
45052HD	PETERBILT	587	CUMMINS ISX15 DIÉSEL	2011-2016
45052HD	VOLVO	VN SERIES	CUMMINS ISX DIÉSEL	2009-2009
45052HD	VOLVO	VN SERIES	CUMMINS ISX15 DIÉSEL	2010-2016
45052HD	VOLVO	VT SERIES	CUMMINS ISX DIÉSEL	2009-2009
45053HD	FREIGHTLINER	FL60	MERCEDES-BENZ MBE 900 DIÉSEL	2001-2004
45053HD	FREIGHTLINER	FL70	MERCEDES-BENZ MBE 900 DIÉSEL	2001-2001
45053HD	FREIGHTLINER	FL80	MERCEDES-BENZ MBE 900 DIÉSEL	2000-2005
45054HD	INTERNATIONAL/NAVISTAR	5500I	CUMMINS ISX DIÉSEL	2003-2007
45054HD	INTERNATIONAL/NAVISTAR	5600I	CUMMINS ISX DIÉSEL	2003-2007
45054HD	INTERNATIONAL/NAVISTAR	5900I	CUMMINS ISX DIÉSEL	2003-2007
45054HD	INTERNATIONAL/NAVISTAR	9200I	CUMMINS ISX DIÉSEL	2003-2007
45054HD	INTERNATIONAL/NAVISTAR	9400I	CUMMINS ISX DIÉSEL	2003-2007
45054HD	INTERNATIONAL/NAVISTAR	9900I	CUMMINS ISX DIÉSEL	2003-2007
45054HD	INTERNATIONAL/NAVISTAR	9900I	CUMMINS ISX15 DIÉSEL	2013-2013
45054HD	INTERNATIONAL/NAVISTAR	9900IX	CUMMINS ISX DIÉSEL	2003-2007
45054HD	KENWORTH	C500	CUMMINS ISX DIÉSEL	2004-2007
45054HD	KENWORTH	C500	CUMMINS ISX15 DIÉSEL	2016-2016
45054HD	KENWORTH	T2000	CUMMINS ISX DIÉSEL	2004-2007
45054HD	KENWORTH	T600	CUMMINS ISX DIÉSEL	2004-2007
45054HD	KENWORTH	T660	CUMMINS ISX DIÉSEL	2007-2007
45054HD	KENWORTH	T800	CUMMINS ISX DIÉSEL	2004-2007
45054HD	KENWORTH	W900	CUMMINS ISX DIÉSEL	2004-2007
45054HD	MACK	CL SERIES	CUMMINS ISX DIÉSEL	2005-2005
45054HD	PETERBILT	379	CUMMINS ISX DIÉSEL	2007-2007
45054HD	PETERBILT	386	CUMMINS ISX DIÉSEL	2007-2007

#	ARMADORA	MODELO	MOTOR	AÑOS
45054HD	PETERBILT	388	CUMMINS ISX15 DIÉSEL	2013-2014
45054HD	PETERBILT	388	CUMMINS ISX-G LNG	2012-2012
45054HD	PETERBILT	567	CUMMINS ISX15 DIÉSEL	2015-2015
45054HD	PETERBILT	579	CUMMINS ISX15 DIÉSEL	2014-2014
45054HD	VOLVO	VN SERIES	CUMMINS ISX DIÉSEL	2004-2007
45055HD	FREIGHTLINER	COLUMBIA	CUMMINS ISM DIÉSEL	2002-2007
45055HD	FREIGHTLINER	CONDOR	CUMMINS ISM DIÉSEL	2001-2003
45055HD	FREIGHTLINER	FL112	CUMMINS ISM DIÉSEL	2001-2002
45055HD	FREIGHTLINER	FLD	CUMMINS ISM DIÉSEL	1999-2002
45055HD	INTERNATIONAL/ NAVISTAR	7700	CUMMINS ISM DIÉSEL	2007-2007
45055HD	INTERNATIONAL/ NAVISTAR	8600	CUMMINS ISM DIÉSEL	2004-2004
45055HD	INTERNATIONAL/ NAVISTAR	9200I	CUMMINS ISM DIÉSEL	2008-2010
45055HD	INTERNATIONAL/ NAVISTAR	PAYSTAR 5500I	CUMMINS ISM DIÉSEL	2008-2012
45055HD	INTERNATIONAL/ NAVISTAR	PAYSTAR 5600I	CUMMINS ISM DIÉSEL	2009-2009
45055HD	INTERNATIONAL/ NAVISTAR	PROSTAR SERIES	CUMMINS ISM DIÉSEL	2009-2010
45055HD	INTERNATIONAL/ NAVISTAR	TRANSTAR 8600	CUMMINS ISM DIÉSEL	2008-2008
45055HD	INTERNATIONAL/ NAVISTAR	WORKSTAR 7600	CUMMINS ISM DIÉSEL	2008-2008
45055HD	INTERNATIONAL/ NAVISTAR	WORKSTAR 7700	CUMMINS ISM DIÉSEL	2008-2009
45055HD	KENWORTH	C500	CUMMINS ISM DIÉSEL	2012-2012
45055HD	KENWORTH	T600	CUMMINS ISM DIÉSEL	2000-2004
45055HD	KENWORTH	T660	CUMMINS ISM DIÉSEL	2008-2012
45055HD	KENWORTH	T800	CUMMINS ISM DIÉSEL	2000-2014
45055HD	KENWORTH	W900	CUMMINS ISM DIÉSEL	1999-2003
45055HD	PETERBILT	357	CUMMINS ISM DIÉSEL	2000-2001
45055HD	PETERBILT	365	CUMMINS ISM DIÉSEL	2008-2008
45055HD	PETERBILT	367	CUMMINS ISM DIÉSEL	2008-2011
45055HD	PETERBILT	384	CUMMINS ISM DIÉSEL	2010-2010
45055HD	PETERBILT	385	CUMMINS ISM DIÉSEL	2000-2000
45055HD	PETERBILT	388	CUMMINS ISM DIÉSEL	2008-2008
45055HD	VOLVO	VN SERIES	CUMMINS ISM DIÉSEL	2003-2003
46002HD	FORD	L8000	DETROIT DIÉSEL SERIES 60 DIÉSEL	1996-1998
46002HD	FORD	L9000	DETROIT DIÉSEL 6 CIL. 11.1 L DIÉSEL	1994-1997
46002HD	FORD	L9000	DETROIT DIÉSEL 6 CIL. 12.7 L DIÉSEL	1996-1997
46002HD	FORD	L9000	DETROIT DIÉSEL SERIES 60 DIÉSEL	1991-1993
46002HD	FREIGHTLINER	CENTURY CLASS	DETROIT DIÉSEL 6 CIL. 11.1 L DIÉSEL	1996-2003
46002HD	FREIGHTLINER	CENTURY CLASS	DETROIT DIÉSEL 6 CIL. 12.7 L DIÉSEL	1996-2007
46002HD	FREIGHTLINER	CENTURY CLASS	DETROIT DIÉSEL 6 CIL. 14.0 L DIÉSEL	2003-2007
46002HD	FREIGHTLINER	CENTURY CLASS	DETROIT DIÉSEL SERIES 55 DIÉSEL	1996-1998
46002HD	FREIGHTLINER	CLASSIC	DETROIT DIÉSEL 6 CIL. 11.1 L DIÉSEL	2001-2002
46002HD	FREIGHTLINER	CLASSIC	DETROIT DIÉSEL 6 CIL. 12.7 L DIÉSEL	2001-2007

#	ARMADORA	MODELO	MOTOR	AÑOS
46002HD	FREIGHTLINER	CLASSIC	DETROIT DIÉSEL 6 CIL. 14.0 L DIÉSEL	2003-2007
46002HD	FREIGHTLINER	CLASSIC XL	DETROIT DIÉSEL 6 CIL. 11.1 L DIÉSEL	2001-2002
46002HD	FREIGHTLINER	CLASSIC XL	DETROIT DIÉSEL 6 CIL. 12.7 L DIÉSEL	2001-2007
46002HD	FREIGHTLINER	CLASSIC XL	DETROIT DIÉSEL 6 CIL. 14.0 L DIÉSEL	2001-2007
46002HD	FREIGHTLINER	COLUMBIA	DETROIT DIÉSEL 6 CIL. 11.1 L DIÉSEL	2000-2001
46002HD	FREIGHTLINER	COLUMBIA	DETROIT DIÉSEL 6 CIL. 12.7 L DIÉSEL	2000-2008
46002HD	FREIGHTLINER	COLUMBIA	DETROIT DIÉSEL 6 CIL. 14.0 L DIÉSEL	2002-2007
46002HD	FREIGHTLINER	CORONADO	DETROIT DIÉSEL 6 CIL. 12.7 L DIÉSEL	2002-2009
46002HD	FREIGHTLINER	CORONADO	DETROIT DIÉSEL 6 CIL. 14.0 L DIÉSEL	2003-2007
46002HD	FREIGHTLINER	FL106	DETROIT DIÉSEL SERIES 50 DIÉSEL	1994-2001
46002HD	FREIGHTLINER	FL112	DETROIT DIÉSEL SERIES 55 DIÉSEL	1997-1998
46002HD	FREIGHTLINER	FLA	DETROIT DIÉSEL 6 CIL. 11.1 L DIÉSEL	1991-1994
46002HD	FREIGHTLINER	FLA	DETROIT DIÉSEL 6 CIL. 12.7 L DIÉSEL	1991-1994
46002HD	FREIGHTLINER	FLB	DETROIT DIÉSEL 6 CIL. 11.1 L DIÉSEL	1994-1999
46002HD	FREIGHTLINER	FLB	DETROIT DIÉSEL 6 CIL. 12.7 L DIÉSEL	1994-1999
46002HD	FREIGHTLINER	FLC	DETROIT DIÉSEL 6 CIL. 11.1 L DIÉSEL	1991-2000
46002HD	FREIGHTLINER	FLC	DETROIT DIÉSEL 6 CIL. 12.7 L DIÉSEL	1991-1998
46002HD	FREIGHTLINER	FLD	DETROIT DIÉSEL 6 CIL. 11.1 L DIÉSEL	1991-2002
46002HD	FREIGHTLINER	FLD	DETROIT DIÉSEL 6 CIL. 12.7 L DIÉSEL	1991-2008
46002HD	FREIGHTLINER	FLD	DETROIT DIÉSEL 6 CIL. 14.0 L DIÉSEL	2001-2007
46002HD	FREIGHTLINER	FLD	DETROIT DIÉSEL SERIES 50 DIÉSEL	1994-1996
46002HD	FREIGHTLINER	FLL	DETROIT DIÉSEL 6 CIL. 11.1 L DIÉSEL	1995-1998
46002HD	FREIGHTLINER	FLL	DETROIT DIÉSEL 6 CIL. 12.7 L DIÉSEL	1990-1998
46002HD	FREIGHTLINER	FLS112	DETROIT DIÉSEL 6 CIL. 11.1 L DIÉSEL	2000-2000
46002HD	FREIGHTLINER	FLS112	DETROIT DIÉSEL 6 CIL. 12.7 L DIÉSEL	2000-2000
46002HD	INTERNATIONAL/ NAVISTAR	8100	DETROIT DIÉSEL 6 CIL. 11.1 L DIÉSEL	1991-1996
46002HD	INTERNATIONAL/ NAVISTAR	8100	DETROIT DIÉSEL 6 CIL. 12.7 L DIÉSEL	1991-1996
46002HD	INTERNATIONAL/ NAVISTAR	8100	DETROIT DIÉSEL SERIES 50 DIÉSEL	1994-1998
46002HD	INTERNATIONAL/ NAVISTAR	8200	DETROIT DIÉSEL 6 CIL. 11.1 L DIÉSEL	1991-1998
46002HD	INTERNATIONAL/ NAVISTAR	8200	DETROIT DIÉSEL 6 CIL. 12.7 L DIÉSEL	1991-1996
46002HD	INTERNATIONAL/ NAVISTAR	8200	DETROIT DIÉSEL SERIES 50 DIÉSEL	1997-1997
46002HD	INTERNATIONAL/ NAVISTAR	8200	DETROIT DIÉSEL SERIES 60 DIÉSEL	1997-1997
46002HD	INTERNATIONAL/ NAVISTAR	8300	DETROIT DIÉSEL 6 CIL. 11.1 L DIÉSEL	1991-1994
46002HD	INTERNATIONAL/ NAVISTAR	8300	DETROIT DIÉSEL 6 CIL. 12.7 L DIÉSEL	1991-1994
46002HD	INTERNATIONAL/ NAVISTAR	9100	DETROIT DIÉSEL SERIES 60 DIÉSEL	1998-1999
46002HD	INTERNATIONAL/ NAVISTAR	9100I	DETROIT DIÉSEL 6 CIL. 12.7 L DIÉSEL	2001-2003
46002HD	INTERNATIONAL/ NAVISTAR	9100I	DETROIT DIÉSEL SERIES 60 DIÉSEL	2000-2000
46002HD	INTERNATIONAL/ NAVISTAR	9200	DETROIT DIÉSEL 6 CIL. 11.1 L DIÉSEL	1994-1997
46002HD	INTERNATIONAL/ NAVISTAR	9200	DETROIT DIÉSEL 6 CIL. 12.7 L DIÉSEL	1994-1997

#	ARMADORA	MODELO	MOTOR	AÑOS
46002HD	INTERNATIONAL/ NAVISTAR	9200	DETROIT DIÉSEL SERIES 60 DIÉSEL	1998-1999
46002HD	INTERNATIONAL/ NAVISTAR	9200I	DETROIT DIÉSEL 6 CIL. 12.7 L DIÉSEL	2001-2003
46002HD	INTERNATIONAL/ NAVISTAR	9200I	DETROIT DIÉSEL SERIES 60 DIÉSEL	2000-2000
46002HD	INTERNATIONAL/ NAVISTAR	9300	DETROIT DIÉSEL 6 CIL. 11.1 L DIÉSEL	1992-1997
46002HD	INTERNATIONAL/ NAVISTAR	9300	DETROIT DIÉSEL 6 CIL. 12.7 L DIÉSEL	1992-1999
46002HD	INTERNATIONAL/ NAVISTAR	9300	DETROIT DIÉSEL SERIES 60 DIÉSEL	1998-1998
46002HD	INTERNATIONAL/ NAVISTAR	9400	DETROIT DIÉSEL 6 CIL. 11.1 L DIÉSEL	1995-1996
46002HD	INTERNATIONAL/ NAVISTAR	9400	DETROIT DIÉSEL 6 CIL. 12.7 L DIÉSEL	1995-1996
46002HD	INTERNATIONAL/ NAVISTAR	9400	DETROIT DIÉSEL SERIES 60 DIÉSEL	1992-1999
46002HD	INTERNATIONAL/ NAVISTAR	9400I	DETROIT DIÉSEL 6 CIL. 12.7 L DIÉSEL	2001-2003
46002HD	INTERNATIONAL/ NAVISTAR	9400I	DETROIT DIÉSEL SERIES 60 DIÉSEL	2000-2000
46002HD	INTERNATIONAL/ NAVISTAR	9900	DETROIT DIÉSEL SERIES 60 DIÉSEL	1999-1999
46002HD	INTERNATIONAL/ NAVISTAR	9900I	DETROIT DIÉSEL 6 CIL. 12.7 L DIÉSEL	2001-2003
46002HD	INTERNATIONAL/ NAVISTAR	9900I	DETROIT DIÉSEL SERIES 60 DIÉSEL	2000-2000
46002HD	INTERNATIONAL/ NAVISTAR	9900IX	DETROIT DIÉSEL 6 CIL. 12.7 L DIÉSEL	2001-2002
46002HD	INTERNATIONAL/ NAVISTAR	9900IX	DETROIT DIÉSEL SERIES 60 DIÉSEL	2000-2000
46002HD	KENWORTH	C500	DETROIT DIÉSEL 6 CIL. 11.1 L DIÉSEL	1991-1994
46002HD	KENWORTH	C500	DETROIT DIÉSEL 6 CIL. 12.7 L DIÉSEL	1991-1994
46002HD	KENWORTH	T2000	DETROIT DIÉSEL 6 CIL. 11.1 L DIÉSEL	1997-2000
46002HD	KENWORTH	T2000	DETROIT DIÉSEL 6 CIL. 12.7 L DIÉSEL	1997-2003
46002HD	KENWORTH	T2000	DETROIT DIÉSEL 6 CIL. 12.7 L DIÉSEL	2001-2001
46002HD	KENWORTH	T600	DETROIT DIÉSEL 6 CIL. 11.1 L DIÉSEL	1991-1999
46002HD	KENWORTH	T600	DETROIT DIÉSEL 6 CIL. 12.7 L DIÉSEL	1991-2003
46002HD	KENWORTH	T800	DETROIT DIÉSEL 6 CIL. 11.1 L DIÉSEL	1991-2001
46002HD	KENWORTH	T800	DETROIT DIÉSEL 6 CIL. 12.7 L DIÉSEL	1991-2003
46002HD	KENWORTH	W900	DETROIT DIÉSEL 6 CIL. 11.1 L DIÉSEL	1991-2006
46002HD	KENWORTH	W900	DETROIT DIÉSEL 6 CIL. 12.7 L DIÉSEL	1991-2006
46002HD	MACK	CH SERIES	DETROIT DIÉSEL 6 CIL. 12.7 L DIÉSEL	1993-1993
46002HD	MACK	CL SERIES	DETROIT DIÉSEL 6 CIL. 12.7 L DIÉSEL	1992-2002
46002HD	MARCOPOLO	VIAGGIO 1000	DETROIT DIÉSEL SERIES 60 DIÉSEL	1996-1996
46002HD	PETERBILT	357	DETROIT DIÉSEL 6 CIL. 11.1 L DIÉSEL	1992-1999
46002HD	PETERBILT	357	DETROIT DIÉSEL 6 CIL. 12.7 L DIÉSEL	1989-2003
46002HD	PETERBILT	377	DETROIT DIÉSEL 6 CIL. 11.1 L DIÉSEL	1992-2000
46002HD	PETERBILT	377	DETROIT DIÉSEL 6 CIL. 12.7 L DIÉSEL	1988-2001
46002HD	PETERBILT	378	DETROIT DIÉSEL 6 CIL. 11.1 L DIÉSEL	1992-1999
46002HD	PETERBILT	378	DETROIT DIÉSEL 6 CIL. 12.7 L DIÉSEL	1988-2004
46002HD	PETERBILT	379	DETROIT DIÉSEL 6 CIL. 11.1 L DIÉSEL	1992-2001

#	ARMADORA	MODELO	MOTOR	AÑOS
46002HD	PETERBILT	379	DETROIT DIÉSEL 6 CIL. 12.7 L DIÉSEL	1988-2003
46002HD	PETERBILT	385	DETROIT DIÉSEL 6 CIL. 12.7 L DIÉSEL	2001-2003
46002HD	PETERBILT	387	DETROIT DIÉSEL 6 CIL. 12.7 L DIÉSEL	2001-2001
46002HD	TEREX	T500 SERIES	DETROIT DIÉSEL 6 CIL. 12.7 L DIÉSEL	2004-2006
46002HD	TEREX	T700 SERIES	DETROIT DIÉSEL 6 CIL. 12.7 L DIÉSEL	2003-2006
46002HD	TEREX	T700 SERIES	DETROIT DIÉSEL 6 CIL. 14.0 L DIÉSEL	2003-2006
46002HD	VOLVO	AUTOHAULER	DETROIT DIÉSEL 6 CIL. 11.1 L DIÉSEL	1996-2001
46002HD	VOLVO	AUTOHAULER	DETROIT DIÉSEL 6 CIL. 12.7 L DIÉSEL	1997-2001
46002HD	VOLVO	AUTOHAULER	DETROIT DIÉSEL SERIES 60 DIÉSEL	1991-1993
46002HD	VOLVO	VHD	DETROIT DIÉSEL SERIES 60 DIÉSEL	2001-2001
46002HD	VOLVO	VN SERIES	DETROIT DIÉSEL 6 CIL. 11.1 L DIÉSEL	1998-2002
46002HD	VOLVO	VN SERIES	DETROIT DIÉSEL 6 CIL. 12.7 L DIÉSEL	1998-2003
46003HD	FREIGHTLINER	COLUMBIA	DETROIT DIÉSEL 6 CIL. 12.7 L DIÉSEL	2005-2005
46003HD	FREIGHTLINER	COLUMBIA	DETROIT DIÉSEL 6 CIL. 14.0 L DIÉSEL	2005-2005
46004HD	FREIGHTLINER	ARGOSY	DETROIT DIÉSEL 6 CIL. 14.0 L	2007-2007
46005HD	FREIGHTLINER	FLA	DETROIT DIÉSEL 6 CIL. 11.1 L	1989-1990
46005HD	FREIGHTLINER	FLA	DETROIT DIÉSEL 6 CIL. 12.7 L	1989-1990
46005HD	FREIGHTLINER	FLC	DETROIT DIÉSEL 6 CIL. 11.1 L	1987-1990
46005HD	FREIGHTLINER	FLC	DETROIT DIÉSEL 6 CIL. 12.7 L	1987-1990
46005HD	FREIGHTLINER	FLD	DETROIT DIÉSEL 6 CIL. 11.1 L	1988-1990
46005HD	FREIGHTLINER	FLD	DETROIT DIÉSEL 6 CIL. 12.7 L	1988-1990
46005HD	FREIGHTLINER	FLT	DETROIT DIÉSEL 6 CIL. 11.1 L	1987-1988
46005HD	FREIGHTLINER	FLT	DETROIT DIÉSEL 6 CIL. 12.7 L	1987-1988
49012	SCANIA	G-SERIES	SCANIA 5 CIL. 8.9 L DIÉSEL	2001-2009
49012	SCANIA	G-SERIES	SCANIA 5 CIL. 9.3 L DIÉSEL	2005-2009
49012	SCANIA	G-SERIES	SCANIA 6 CIL. 11.7 L DIÉSEL	2009-2010
49012	SCANIA	G-SERIES	SCANIA 6 CIL. 12.7 L DIÉSEL	2008-2011
49012	SCANIA	P-SERIES	SCANIA 5 CIL. 8.9 L DIÉSEL	2001-2009
49012	SCANIA	P-SERIES	SCANIA 5 CIL. 9.3 L DIÉSEL	2006-2006
49012	SCANIA	P-SERIES	SCANIA 5 CIL. 9.3 L DIÉSEL	2007-2009
49012	SCANIA	P-SERIES	SCANIA 6 CIL. 11.0 L DIÉSEL	2006-2006
49012	SCANIA	P-SERIES	SCANIA 6 CIL. 11.0 L DIÉSEL	2007-2009
49012	SCANIA	P-SERIES	SCANIA 6 CIL. 11.7 L DIÉSEL	2008-2010
49012	SCANIA	P-SERIES	SCANIA 6 CIL. 12.7 L DIÉSEL	2008-2011
49012	SCANIA	P-SERIES	SCANIA 6 CIL. 15.6 L DIÉSEL	2006-2006
49012	SCANIA	P-SERIES	SCANIA 6 CIL. 15.6 L DIÉSEL	2007-2009
49012	SCANIA	R-SERIES	SCANIA 6 CIL. 11.0 L DIÉSEL	2006-2006
49012	SCANIA	R-SERIES	SCANIA 6 CIL. 11.0 L DIÉSEL	2007-2009
49012	SCANIA	R-SERIES	SCANIA 6 CIL. 11.7 L DIÉSEL	2009-2010
49012	SCANIA	R-SERIES	SCANIA 6 CIL. 12.7 L DIÉSEL	2008-2011
49012	SCANIA	R-SERIES	SCANIA 6 CIL. 15.6 L DIÉSEL	2006-2009

BOMBAS DE AGUA CON APLICACIÓN POR MOTOR**CUMMINS**

NO. DE PARTE	APLICACIÓN
45052HD	CUMMINS ISX 12 RIBS EGR CON BASE
45054HD	CUMMINS ISX 12 RIBS
45051HD	CUMMINS ISX 10 RIBS
44052HD	CUMMINS N14
44092HD	CUMMINS BIG CAM 350
41181	CUMMINS SERIES ISB
42291	CUMMINS 6 CIL 6.7 L DIÉSEL
42146HD	CUMMINS ISC DIÉSEL
42352HD	CUMMINS SERIES C 6 CIL 8.3L DIÉSEL
43566HD	CUMMINS ISL (M2)
45055HD	CUMMINS ISM VÁSTAGO CORTO
43307HD	CUMMINS M11 VÁSTAGO LARGO
44094HD	CUMMINS L10

DETROIT

NO. DE PARTE	APLICACIÓN
44057HD	DETROIT DIÉSEL DD15 - DD13
46005HD	DETROIT DIÉSEL 11.1L SERIES 60
44066HD	DETROIT DIÉSEL 12.7 L SERIES 60
46003HD	DETROIT DIÉSEL 12.7 L SERIES 60 EGR
46004HD	DETROIT DIÉSEL 14.0 L SERIES 60 - 50 CON EGR

MERCEDEZ-BENZ

NO. DE PARTE	APLICACIÓN
45053HD	MERCEDES BENZ MBE 904 DIÉSEL UN SOLO TERMOSTATO
45050HD	MERCEDES BENZ MBE 906 DIÉSEL M2 DOBLE TERMOSTATO

INTERNATIONAL / NAVISTAR

NO. DE PARTE	APLICACIÓN
42318HD	NAVISTAR DT408, DT466 y DT530 DIÉSEL (MOTOR MECANICO TIPO VIEJO)
43325HD	NAVISTAR DT466 DIÉSEL (TIPO NUEVO)
44058HD	NAVISTAR DERECHA DT 466 7.6L
44059HD	NAVISTAR IZQUIERDA DT 466 7.6L
43545HD	INTERNATIONAL NAVISTAR T444 DIÉSEL
44053HD	INTERNATIONAL NAVISTAR T444 y V8 7.3L DIÉSEL

























CATERPILLAR

NO. DE PARTE	APLICACIÓN
44051HD	CATERPILLAR C16
44062HD	CATERPILLAR C15
44054HD	CATERPILLAR 3406
44060HD	CATERPILLAR C12

A close-up photograph of an engine's internal components, specifically focusing on the valve train mechanism. The image shows several circular metal parts, likely valve covers or camshaft caps, with various bolts and nuts. The lighting is dramatic, highlighting the metallic textures and creating deep shadows. A search bar overlay is positioned in the lower-left quadrant, featuring the text 'BÚSQUEDA POR IMAGEN' in white, bold, uppercase letters. Below the text is a series of diagonal white lines representing a search bar's input field.

**BÚSQUEDA
POR IMAGEN**



<p>41111HD</p> 	<p>41175HD</p> 	<p>41181</p> 	<p>41199HD</p> 
<p>42133</p> 	<p>42146HD</p> 	<p>42291</p> 	<p>42318HD</p> 
<p>43236HD</p> 	<p>43240HD</p> 	<p>43307HD</p> 	<p>43325HD</p> 
<p>43545HD</p> 	<p>43554HD</p> 	<p>43561HD</p> 	<p>44051HD</p> 
<p>44052HD</p> 	<p>44054HD</p> 	<p>44057HD</p> 	<p>44058HD</p> 
<p>44059HD</p> 	<p>44060HD</p> 	<p>44062HD</p> 	<p>44066HD</p> 

BÚSQUEDA POR IMAGEN

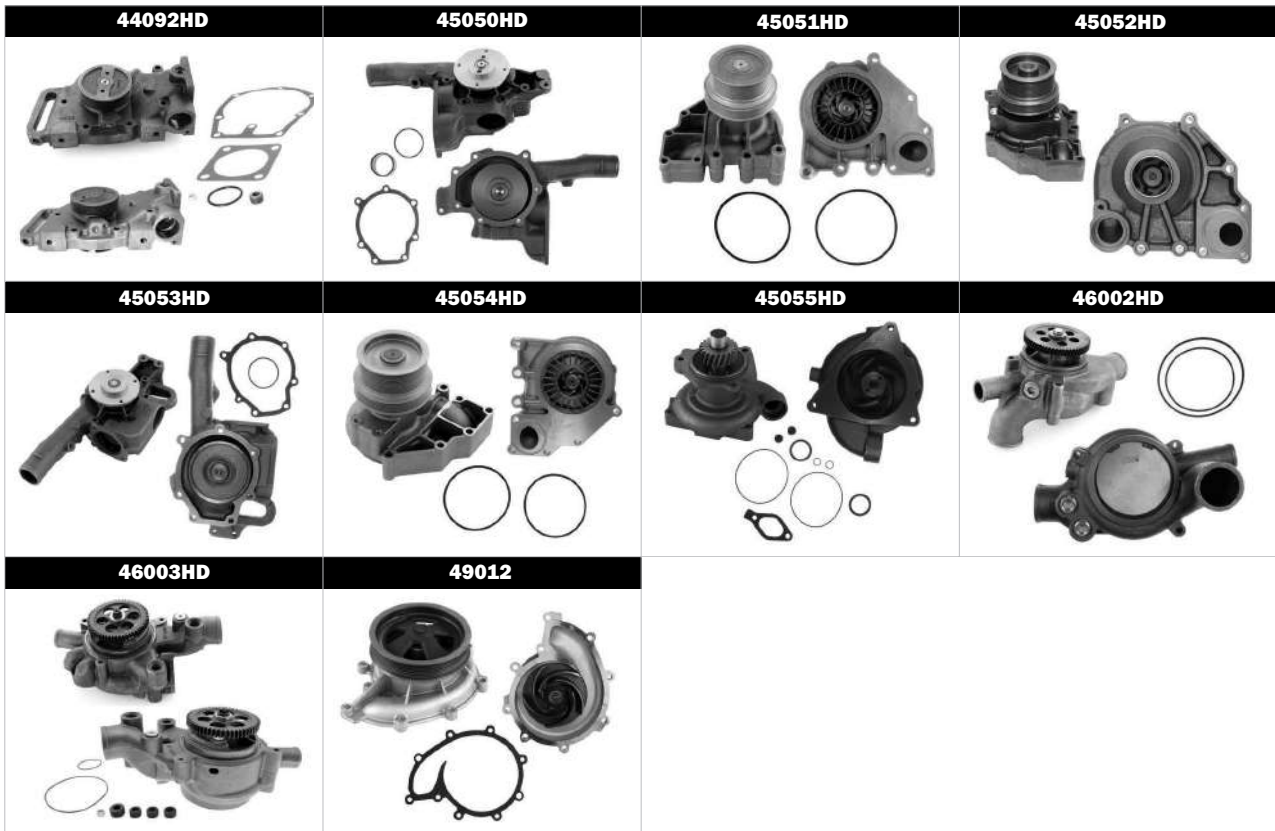



DRIVEN BY POSSIBILITY™





DRIVEN BY POSSIBILITY™

GATES DE MÉXICO S.A. DE C.V.

Vasco de Quiroga N° 3200, Piso 1, Centro Ciudad Santa Fe, C.P. 01210,
Álvaro Obregón, CDMX
Tel. 55 2000 2700

CDS VESTA

Calle Isidro Fabela N° 120, Vesta Park Toluca II, Edificio industrial S-6,
San Blas Oztzacatipan, C.P. 50230, Toluca, México
Tel. 722 265 5300

CDS GUADALAJARA

Carretera a San Martín de las Flores N° 520, Parque Industrial Prologis El Salto,
Nave 2B, C.P. 45629, Tlaquepaque, Jalisco.
Tel. 33 3001 8200

CDS MONTERREY

Blvd. José López Portillo N° 333, Interior bodegas 207 y 209, Col. Valle del Canadá,
C.P. 66050, General Escobedo, Nuevo León.
Tel. 81 8852 8000

La información contenida en este catálogo técnico es la correcta hasta el momento de su impresión y está sujeta a cambios sin previo aviso; por lo cual no asumimos responsabilidad alguna por sus errores u omisiones, para actualizaciones, queda expresamente prohibida la reproducción total o parcial de este material, sin el permiso expreso y por escrito de Gates de México S.A. de C.V.

La distribución de este catálogo técnico es gratuita.

**PARA MAYOR INFORMACIÓN FAVOR DE CONTACTAR
A TU REPRESENTANTE DE VENTAS GATES.**